



# BOSTIK

PRO SERIES

# FIRE PROTECT

PASSIVE FIRE RESISTANT  
SOLUTIONS FOR LINEAR JOINTS  
AND SERVICE PENETRATIONS



FIRE PROTECT



#### BOSTIK

The new logo and the new house style with the characteristic green gecko is more than just a visual appearance. “Smart Adhesives” is a reflection of our positioning with regard to the development of smart and innovative sealing and bonding solutions that are safe, flexible and efficient.

We develop innovative sealing and bonding solutions that, whatever is constructed, connected or built, are smarter and can adjust better to the forces and challenges in our daily life.

#### THE GECKO - INSPIRING ADHESION

For centuries, scientists have been inspired by geckos because of their unique bonding mechanism. They can stick to almost any surface, can climb super-fast against smooth polished glass and can easily carry their entire body weight with just one toe.

The Bostik gecko is flexible, easy to adapt to environments, is open to new situations and is courageous. It symbolizes Bostik's smart and innovative sealing and bonding solutions for the challenges which today's market faces.

# FIRE PROTECT INTRODUCTION

**Bostik Fire Protect is a complete, fully certified, approved range of passive fire resistant products for use in movement joints, connection joints, openings and service penetrations between fire compartments.**



**Passive fire resistant products are the primary means, used in the construction of a building, of limiting the spread of flames, heat and smoke and hugely increasing fire safety.**

By correct application of these products the basic, legal compartmentalisation requirements will be met. These products contribute to the structural stability of a building and provide time for people to get out of a building safely and gives emergency services time to act and fight the fire. Passive fire resistance limits the spread of flames and smoke and thus the transfer and flashover of fire between compartments.

#### PASSIVE FIRE PROTECTION:

- SAVES LIVES
- LIMITS MATERIAL DAMAGE LOSS
- MINIMISES BUSINESS LOSS
- PROTECTS THE BUILDING, WHICH MEANS IT IS ACCESSIBLE AFTER THE FIRE

Creating fire compartments in a building is an essential part of passive fire safety. The underlying aim is to restrict the spread of smoke and flames in the case of a fire to one single compartment and thus to slow down the spread of the fire.

As passive fire safety is becoming increasingly important, both in new buildings and in renovation work, Bostik has decided to focus its efforts on product development and certification for this market segment. With our huge experience in the field of solutions for linear joints (EN 1366-4) we are proud to present our Fire Protect range which also includes solutions for openings and service penetrations (EN 1366-3).

**Reaction to fire is a completely different matter than fire resistance. Both are strictly regulated in national and international standards.**

**Reaction to fire**

Reaction to fire indicates how flammable/combustible a material is and how much it contributes to the development of a fire. Well-known standards for reaction to fire are the German standard DIN4102 part 1, with classifications A1, A2, B1, B2 and B3 and the European EN 13501-1, with classifications A1, A2, B, C, D, E and F to determine combustibility and additional classification s1, s2, s3 for smoke development and d0, d1 and d2 for burning droplets and particles.

**Fire resistance**

Fire resistance on the other hand is the time, expressed minutes, in which a burning compartment is able to successfully fulfil its role and thus prevent the fire from spreading. This fire resistance of (combined) products has been tested and measured in standardised, common applications. This means that a product with the highest classification for reaction to fire does not offer any guarantee of fire resistance.

**THIS BROCHURE SETS OUT ALL THE ESSENTIAL INFORMATION ABOUT COMMON APPLICATIONS AS WELL AS LISTING THE SOLUTIONS THAT WE PROVIDE FOR YOU TO BE ABLE TO MEET FIRE RESISTANCE REQUIREMENTS.**

Bostik is well-known as one of the leading developers and manufacturers of sealants, adhesives and PU foam and is regarded als an authority in the field of dedicated concepts that provide complete solutions.

With the name Bostik Fire Protect, Bostik has developed a complete range of passive fire resistant solutions. The main goal of this range is to offer efficient solutions with the newest technologies. All products and applications are fully tested and certified according to the latest European standards. All Bostik Fire Protect products mentioned in this brochure are ETA/CE marked and are UL-EU certified.



# FIRE PROTECT CONTENT

1.	INTRODUCTION	PAGE 3
2.	LINEAR JOINTS (EN 1366-4)	PAGE 5
3.	PRODUCT PORTFOLIO LINEAR JOINTS	PAGE 7
4.	PRODUCT SELECTOR LINEAR JOINTS	PAGE 13
5.	APPLICATION AREAS LINEAR JOINTS	PAGE 22
6.	SERVICE PENETRATIONS (EN 1366-3)	PAGE 25
7.	PRODUCT PORTFOLIO SERVICE PENETRATIONS	PAGE 27
8.	PRODUCT SELECTOR SERVICE PENETRATIONS	PAGE 37
9.	APPLICATION AREAS SERVICE PENETRATIONS	PAGE 42
10.	CERTIFICATION & TESTING	PAGE 45
11.	EXPLANATION OF THE ICONS	PAGE 48



# FIRE PROTECT LINEAR JOINTS (EN 1366-4)



**A fire compartment consists of fire resistant walls and floors. A compartment is completed by a sound fire resistant seal of joints between these walls and floors.**

The fire resistance of our solutions for sealing these linear joints has been tested in accordance with European Norm 1366-4 by a certified laboratory (notified body) on different surfaces and multiple joint widths. The results of these tests are summarised in classification reports. These specially developed products can be used separately, but combinations of products have also been tested. This enables Bostik to provide an efficient solution for every situation.



**The fire resistance of our solutions for sealing these linear joints has been tested in accordance with European Norm 1366-4 by a certified laboratory (notified body) on different surfaces and multiple joint widths.**

THE RESULTS OF THESE TESTS ARE SUMMARISED IN CLASSIFICATION REPORTS. THESE SPECIALLY DEVELOPED PRODUCTS CAN BE USED SEPARATELY, BUT COMBINATIONS OF PRODUCTS HAVE ALSO BEEN TESTED. THIS ENABLES BOSTIK TO PROVIDE AN EFFICIENT SOLUTION FOR EVERY SITUATION.

**Peutz Laboratory for Fire Safety - independent type testing**

The Bostik products used for fire resistant linear joint seals are extensively tested in the Peutz Laboratory for Fire Safety by means of the standard EN 1366-4. The laboratory is accredited to EN-ISO/IEC 17025 (L505) by the Dutch Accreditation Council (RvA) and recognized as a Notified Body by the Dutch Government (NB2264).

The fire resistance is a means to measure how long a test specimen can withstand a fire, in this case linear joint seals made of Bostik products. During a fire test of linear joint seals, multiple seals with a minimum length of 900 mm are installed in a supporting construction the size of the furnace, 4 m wide and 3 m high. Inside the furnace the temperature is controlled by gas burners according to the standard heating curve, which leads to a temperature of more than 800 °C after 30 minutes and almost 1000 °C after one hour. During the test the linear joint seals are monitored visually and electronically in order to determine failure of performance criteria such as temperature and integrity.

The accreditation and notification of the laboratory guarantees to manufacturers, suppliers and users that the products are tested independently, are not arbitrary and can be used in all member states of the European Union. Last but not least, Peutz laboratories also tested these Bostik products regarding reaction to fire, smoke control and acoustics.



FIRE PROTECT

# PRODUCT PORTFOLIO

## LINEAR JOINTS (EN 1366-4)

Our solutions for linear joints consist of:

- BOSTIK FP401 FIRESEAL ACRYLIC
- BOSTIK FP402 FIRESEAL SILICONE
- BOSTIK FP403 FIRESEAL HYBRID
- BOSTIK FP404 FIRE RETARDANT PU FOAM
- BOSTIK FP404 FIRE RETARDANT PU GUN FOAM

# FP401 FIRESEAL ACRYLIC

## A 1-COMPONENT FIRE RESISTANT SEALANT BASED ON ACRYLIC DISPERSION.

FP401 Fireseal Acrylic is a plasto-elastic sealant which is suitable for up to 4 hours of fire resistant sealing of linear connection joints in gypsum and stony substrates. Fire resistance tested according to EN 1366-4.



### Most important characteristics

- Fire resistance up to 4 hours
- Can be applied separately and in combination with FP404 Fire Retardant PU (Gun)Foam in joints up to 40mm wide
- Can be applied in both vertical and horizontal joints
- Also certified for joints in metal-stud walls
- Excellent application and easy to finish
- Paintable with most water based and synthetic paints
- High sound insulation
- 18 months storage time (under correct conditions)
- Tested for smoke resistance
- Can be applied single-sided

### Certificates / testreports

- ETA-20/1250
- Sound reduction measured according to ISO 10140-1:2012, up to Rs,w 53 dB
- A+ French VOC Regulation
- Emission EC1Plus
- Fire class B-s1,d0 according to EN 13501-1
- CE marking
- UL-EU
- Smoke leakage Sa / S200 according EN 1634-3

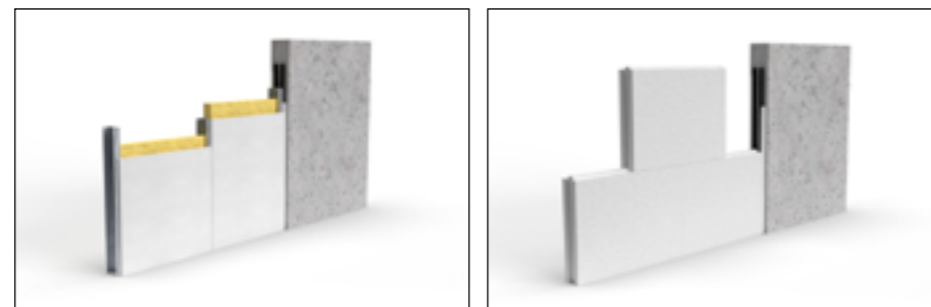

Article number	EAN code	Colour	Packaging	Packed per
30612846	8713572041365	white	cartridge 310ml	12 pieces in a box
30620687	8711595220521	grey	cartridge 310ml	12 pieces in a box
30623503	8711595225120	white	sausage 600ml	12 pieces in a box
30623622	8711595225144	grey	sausage 600ml	12 pieces in a box

# FP402 FIRESEAL SILICONE

## A 1-COMPONENT FIRE RESISTANT, NEUTRAL CURING SILICONE SEALANT.

FP402 Fireseal Silicone is specifically developed for fire resistant sealing of connection joints in constructions. Fire resistance tested according to EN 1366-4.



### Most important characteristics

- Fire resistance up to 4 hours
- Can be applied separately and in combination with FP404 Fire Retardant PU (Gun)Foam in joints up to 50mm wide
- Excellent application, does not slump
- UV, water and weather resistant
- Also suitable for external use
- Not paintable
- Tested for smoke resistance
- Can be applied single-sided

### Certificates / testreports

- ETA-20/1249
- A+ French VOC Regulation
- Fire class B-s1,d0 according to EN 13501-1
- CE marking
- Emission EC1Plus
- M1 certificate
- ISEGA
- Sound reduction measured according to ISO 10140-1:2012, up to Rs,w 48 dB
- UL-EU
- Smoke leakage Sa / S200 according EN 1634-3

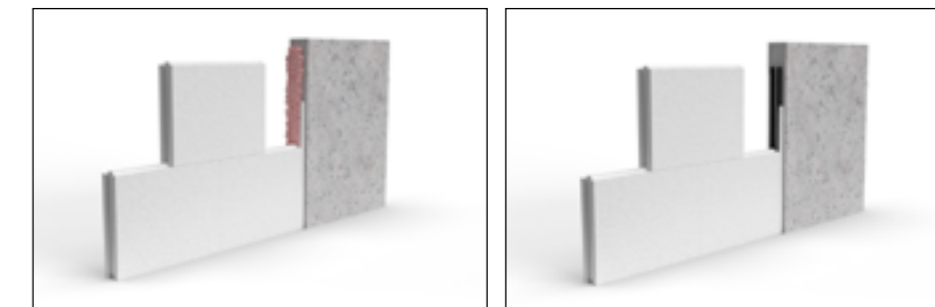

Article number	EAN code	Colour	Packaging	Packed per
30622931	8711595221399	white	cartridge 310ml	12 pieces in a box
30622929	8711595221412	grey	cartridge 310ml	12 pieces in a box
30622990	8711595221436	black	cartridge 310ml	12 pieces in a box
30622930	8711595221450	white	sausage 600 ml	12 pieces in a box
30622928	8711595221474	grey	sausage 600 ml	12 pieces in a box
30622989	8711595221498	black	sausage 600 ml	12 pieces in a box



Consult the Technical Data Sheet for more information. Examples of applications of the BOSTIK FP401 FIRESEAL ACRYLIC are shown on the right side of this page. For all certified applications please view the Application Guidelines. Always consult the Peutz Classification Reports prior to application to ensure to achieve the intended fire resistance.



Consult the Technical Data Sheet for more information. Examples of applications of the BOSTIK FP402 FIRESEAL SILICONE are shown on the right side of this page. For all certified applications please view the Application Guidelines. Always consult the Peutz Classification Reports prior to application to ensure to achieve the intended fire resistance.

# FP403 FIRESEAL HYBRID

## A 1-COMPONENT, FIRE RESISTANT HYBRID BASED SEALANT.

Bostik FP403 Fireseal Hybrid is suitable for fire resistant sealing of linear joints up to 4 hours. Offers a moving absorption of 25%. This hybrid sealant can be applied in both vertical and horizontal joints. Sealing wall and floor or ceiling, (metal) frames and all possible metal stud (gypsum) connections are certified too.



Consult the Technical Data Sheet for more information. Examples of applications of the BOSTIK FP403 FIRESEAL HYBRID are shown on the right side of this page. For all certified applications please view the Application Guidelines. Always consult the Peutz Classification Reports prior to application to ensure to achieve the intended fire resistance.

### Most important characteristics

- Fire resistance up to 4 hours
- Can be applied in joints up to 60mm wide
- Suitable for wall/ceiling and wall/floor connections
- Certified for steel and wooden frames
- Certified for metal-stud connections
- Excellent application and easy toolability
- Joint movement up to 25%
- Paintable with most water based and synthetic paints
- Minimum shrinkage
- UV, water and weather resistant
- High sound insulation
- 18 months storage time (under correct conditions)
- Tested for smoke resistance
- Can be applied single-sided

### Certificates/testreports

- ETA-20/1119
- Sound reduction measured according to ISO 10140-1:2012, up to Rs,w 53 dB
- A+ French VOC Regulation
- Emission EC1Plus
- Fire class B-s1,d0 according to EN 13501-1
- CE marking
- M1 certificate
- UL-EU
- Smoke leakage Sa / S200 according EN 1634-3

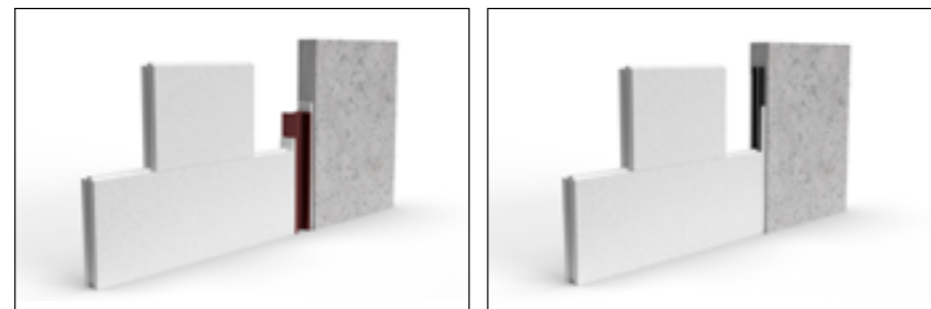

Article number	EAN code	Colour	Packaging	Packed per
30612887	8713572041419	white	cartridge 290ml	12 pieces in a box
30612851	8713572041402	grey	cartridge 290ml	12 pieces in a box
30620686	8711595220545	white	sausage 600 ml	12 pieces in a box
30620668	8711595220569	grey	sausage 600 ml	12 pieces in a box

# FP404 FIRE RETARDANT PU FOAM

## A MODIFIED, 1-COMPONENT, FIRE RESISTANT POLYURETHANE FOAM.

Bostik FP404 Fire Retardant PU Foam offers fire resistance up to 120 minutes. Combined with other FP products up to 4 hours! Can be applied with hand adapter. The cans Bostik FP404 Fire Retardant PU Foam are equipped with an adapter to apply the foam easy and accurate by hand.



Consult the Technical Data Sheet for more information. Examples of applications of the BOSTIK FP404 FIRE RETARDANT PU FOAM are shown on the right side of this page. For all certified applications please view the Application Guidelines. Always consult the Peutz Classification Reports prior to application to ensure to achieve the intended fire resistance.

### Most important characteristics

- Applied separately up to 2 hours fire resistant, combined with other Bostik Fire Protect products up to 4 hours
- For use in joints up to 40mm wide
- Certified for wall-floor and wall-ceiling connections
- Also certified for wooden frames
- Easy to apply with adapter
- Simple and quick processing
- Tack free in 10 to 12 minutes
- High sound insulation
- Tested for smoke resistance

### Certificates/testreports

- ETA-20/1118
- DIN4102 - Part 1 - Class B1
- Fire class B-s1,d0 according to EN 13501-1
- Sound reduction measured according to ISO 10140-1:2012, up to Rs,w 53 dB
- A+ French VOC Regulation
- Emission EC1Plus
- CE marking
- M1 certificate
- UL-EU
- Smoke leakage Sa / S200 according EN 1634-3



Article number	EAN code	Colour	Packaging	Packed per
30612888	8713572041433	pink	cannister 750 ml	12 pieces in a box

# FP404 FIRE RETARDANT PU GUNFOAM

**A MODIFIED, 1-COMPONENT, FIRE RESISTANT POLYURETHANE FOAM.**

Bostik FP404 Fire Retardant PU GunFoam offers fire resistance up to 120 minutes. Combined with other FP products up to 4 hours! Can be applied with gun. The cans Bostik FP404 Fire Retardant PU GunFoam are equipped with a connection to process the foam professionally with a PU Foamgun.



Consult the Technical Data Sheet for more information. Examples of applications of the BOSTIK FP404 FIRE RETARDANT PU GUNFOAM are shown on the right side of this page. For all certified applications please view the Application Guidelines. Always consult the Peutz Classification Reports prior to application to ensure to achieve the intended fire resistance.

### Most important characteristics

- Applied separately up to 2 hours fire resistant, combined with other Bostik Fire Protect products up to 4 hours
- For use in joints up to 40mm wide
- Certified fo wall-floor / wall-ceiling connections
- Also certified for wooden frames
- Easy to apply with gun
- Simple and quick processing
- Tack free in 10 to 12 minutes
- High sound insulation
- Tested for smoke resistance

### Certificates/testreports

- ETA-20/1118
- DIN4102 - Part 1 - Class B1
- Fire class B-s1,d0 according to EN 13501-1
- Sound reduction measured according to ISO 10140-1:2012, up to Rs,w 53 dB
- A+ French VOC Regulation
- Emission EC1Plus
- CE marking
- M1 certificate
- UL-EU
- Smoke leakage Sa / S200 according EN 1634-3

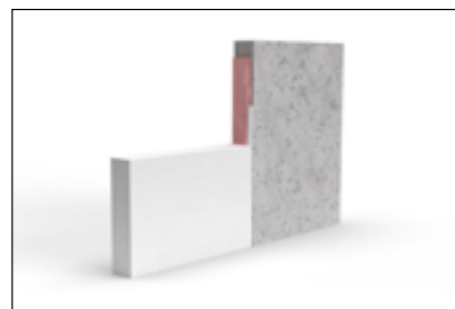

Article number	EAN code	Colour	Packaging	Packed per
30612850	8713572041426	pink	cannister 750 ml	12 pieces in a box

# PRODUCT SELECTOR

## LINEAR JOINTS

### STONE TO STONE WALL ≥ 70 MM

Orientation	Floor thickness	Valid for wall	Valid for wall abutting a floor	Movement	Joint width	E/EI	Minutes	Product	Application	Classification	ETA	ETA page
vertical		X			5-10	EI	45	FP401	FP401 unexposed face	EI 45 - V - X - F - W 5 to 10	ETA-20/1250	5
vertical		X			5-10	EI	60	FP403	FP403 unexposed face	EI 60 - V - X - F - W 5 to 10	ETA-20/1119	5
vertical		X			8-10	EI	30	FP404	FP404 fully filled	EI 30 - V - X - F - W 8 to 10	ETA-20/1118	5
vertical		X			5-20	E	240	FP401	FP401 unexposed face	E 240 - V - X - F - W 5 to 20	ETA-20/1250	5
vertical		X			5-20	E	240	FP403	FP403 unexposed face	E 240 - V - X - F - W 5 to 20	ETA-20/1119	5
vertical		X			8-20	EI	45	FP401 & FP404	FP401 exposed face, FP404 unexposed face	EI 45 - V - X - F - W 8 to 20	ETA-20/1250, 20/1118	5, 10
vertical		X			8-20	E	240	FP401 & FP404	FP401 exposed face, FP404 unexposed face	E 240 - V - X - F - W 8 to 20	ETA-20/1250, 20/1118	5, 10
vertical		X			10-20	EI	20	FP404	FP404 fully filled	EI 20 - V - X - F - W 10 to 20	ETA-20/1118	5
vertical		X			10-20	EI	30	FP401	FP401 unexposed face	EI 30 - V - X - F - W 10 to 20	ETA-20/1250	5
vertical		X			10-20	EI	45	FP403	FP403 unexposed face	EI 45 - V - X - F - W 10 to 20	ETA-20/1119	5
horizontal	≥ 100 mm	X	X		8-15	EI	45	FP404	FP404 fully filled	EI 45 - T - X - F - W 8 to 15	ETA-20/1118	7
horizontal	≥ 150 mm	X	X		8-19	EI	30	FP404	FP404 fully filled	EI 30 - T - X - F - W 8 to 19	*	*
horizontal	≥ 150 mm	X	X		8-19	EI	60	FP401 & FP404	FP401 exposed face 1mm, FP404 unexposed face	EI 60 - T - X - F - W 8 to 19	*	*

## STONE TO STONE WALL ≥ 100 MM

Orientation	Floor thickness	Valid for wall	Valid for wall abutting a floor	Movement	Joint width	E/EI	Minutes	Product	Application	Classification	ETA	ETA page
vertical		X			5-10	EI	180	FP401	FP401 both faces	EI 180 – V – X – F – W 5 to 10	ETA-20/1250	6
vertical		X			8-10	EI	90	FP404	FP404 fully filled	EI 90 – V – X – F – W 8 to 10	ETA-20/1118	5
vertical		X			8-30	EI	90	FP401 & FP404	FP401 exposed face, FP404 unexposed face	EI 90 – V – X – F – W 8 to 30	ETA-20/1250, 20/1118	6, 10
vertical		X			8-30	E	120	FP401 & FP404	FP401 exposed face, FP404 unexposed face	E 120 – V – X – F – W 8 to 30	ETA-20/1250, 20/1118	6, 10
vertical		X			10-30	EI	45	FP404	FP404 fully filled	EI 45 – V – X – F – W 10 to 30	ETA-20/1118	5
vertical		X			5-40	EI	30	FP402	FP402 exposed face	EI 30 – V – X – F – W 5 to 40	ETA-20/1249	5
vertical		X			5-40	EI	60	FP402	FP402 unexposed face	EI 60 – V – X – F – W 5 to 40	ETA-20/1249	5
vertical		X			5-40	EI	60	FP403	FP403 exposed face	EI 60 – V – X – F – W 5 to 40	ETA-20/1119	6
vertical		X			5-40	EI	60	FP403	FP403 unexposed face	EI 60 – V – X – F – W 5 to 40	ETA-20/1119	6
vertical		X			5-40	EI	180	FP401	FP401 exposed face	EI 180 – V – X – F – W 5 to 40	ETA-20/1250	6
vertical		X			5-40	E	120	FP403	FP403 exposed face	E 120 – V – X – F – W 5 to 40	ETA-20/1119	6
vertical		X			5-40	E	240	FP401	FP401 both faces	E 240 – V – X – F – W 5 to 40	ETA-20/1250	6
vertical		X			5-40	E	240	FP402	FP402 unexposed face	E 240 – V – X – F – W 5 to 40	ETA-20/1249	5
vertical		X			5-40	E	240	FP403	FP403 unexposed face	E 240 – V – X – F – W 5 to 40	ETA-20/1119	6
vertical		X			8-40	EI	45	FP403 & FP404	FP403 exposed face, FP404 unexposed face	EI 45 – V – X – F – W 8 to 40	ETA-20/1119, 20/1118	6, 10
vertical		X			8-40	E	120	FP403 & FP404	FP403 exposed face, FP404 unexposed face	E 120 – V – X – F – W 8 to 40	ETA-20/1119, 20/1118	6, 10
vertical		X			10-40	EI	240	FP401	FP401 both faces	EI 240 – V – X – F – W 10 to 40	ETA-20/1250	6
vertical		X			30-40	EI	30	FP401 & FP404	FP401 exposed face, FP404 unexposed face	EI 30 – V – X – F – W 30 to 40	ETA-20/1250, 20/1118	6, 10
vertical		X			5-50	EI	180	FP402	FP402 both faces	EI 180 – V – X – F – W 5 to 50	ETA-20/1249	5
vertical		X			5-50	E	240	FP402	FP402 both faces	E 240 – V – X – F – W 5 to 50	ETA-20/1249	5
vertical		X			10-50	EI	240	FP403	FP403 both faces	EI 240 – V – X – F – W 5 to 50	ETA-20/1119	6
vertical		X			5-60	E	240	FP403	FP403 both faces	E 240 – V – X – F – W 5 to 60	ETA-20/1119	6
vertical		X			50-60	EI	180	FP403	FP403 both faces	EI 180 – V – X – F – W 50 to 60	ETA-20/1119	6
horizontal	≥ 100 mm		X		8	EI	60	FP404	FP404 fully filled	EI 60 – T – X – F – W 8	ETA-20/1118	7
horizontal	≥ 100 mm		X		10	EI	90	FP402	FP402 exposed face	EI 90 – T – X – F – W 10	ETA-20/1249	8
horizontal	≥ 100 mm		X		10	EI	90	FP403	FP403 exposed face	EI 90 – T – X – F – W 10	ETA-20/1119	10
horizontal	≥ 100 mm		X		10	EI	120	FP402	FP402 unexposed face	EI 120 – T – X – F – W 10	ETA-20/1249	9
horizontal	≥ 100 mm		X		10	EI	120	FP403	FP403 unexposed face	EI 120 – T – X – F – W 10	ETA-20/1119	10
horizontal	≥ 100 mm		X		10	E	120	FP402	FP402 exposed face	E 120 – T – X – F – W 10	ETA-20/1249	8
horizontal	≥ 150 mm	X	X		8-15	EI	120	FP401 & FP404	FP401 exposed face 1mm, FP404 unexposed face	E 120 – T – X – F – W 8-15	*	*

## STONE TO STONE WALL ≥ 100 MM

Orientation	Floor thickness	Valid for wall	Valid for wall abutting a floor	Movement	Joint width	E/EI	Minutes	Product	Application	Classification	ETA	ETA page
horizontal	≥ 100 mm		X		8-20	EI	45	FP404	FP404 fully filled	EI 45 – T – X – F – W 8 to 20	ETA-20/1118	7
horizontal	≥ 150 mm	X	X		8-20	EI	60	FP404	FP404 fully filled	EI 60 – T – X – F – W 8 to 20	*	*
horizontal	≥ 100 mm		X		10-25	EI	30	FP402	FP402 exposed face	EI 30 – T – X – F – W 10 to 25	ETA-20/1249	8
horizontal	≥ 100 mm		X		10-25	EI	90	FP402	FP402 unexposed face	EI 90 – T – X – F – W 10 to 25	ETA-20/1249	9
horizontal	≥ 100 mm		X		10-25	E	60	FP402	FP402 exposed face	E 60 – T – X – F – W 10 to 25	ETA-20/1249	8
horizontal	≥ 100 mm		X		10-25	E	120	FP403	FP403 unexposed face	E 120 – T – X – F – W 10 to 25	ETA-20/1119	10
horizontal	not specified	X	X	5	10-30	EI	180	FP401	FP401 both faces	EI 180 – T – M 5 – F – W 10 to 30	ETA-20/1250	8
horizontal	≥ 100 mm	X	X	25	10-30	EI	240	FP403	FP403 both faces	EI 240 – T – M 25 – F – W 10 to 30	ETA-20/1119	9
horizontal	not specified	X	X	5	10-30	E	240	FP401	FP401 both faces	E 240 – T – M 5 – F – W 10 to 30	ETA-20/1250	8
horizontal	≥ 150 mm	X	X		15-30	EI	60	FP401 & FP404	FP401 exposed face 1mm, FP404 unexposed face	E 60 – T – X – F – W 15-30	*	*
horizontal	≥ 100 mm		X		20-30	EI	30	FP404	FP404 fully filled	EI 30 – T – X – F – W 20 to 30	ETA-20/1118	7
horizontal	≥ 100 mm		X		10-40	EI	30	FP403	FP403 exposed face	EI 30 – T – X – F – W 10 to 40	ETA-20/1119	10
horizontal	≥ 100 mm		X		10-40	EI	60	FP403	FP403 unexposed face	EI 60 – T – X – F – W 10 to 40	ETA-20/1119	10
horizontal	≥ 100 mm		X		10-40	E	120	FP402	FP402 unexposed face	E 120 – T – X – F – W 10 to 40	ETA-20/1249	9
horizontal	≥ 100 mm		X		10-40	E	120	FP403	FP403 exposed face	E 120 – T – X – F – W 10 to 40	ETA-20/1119	10
horizontal	≥ 100 mm	X	X	25	10-40	E	240	FP403	FP403 both faces	E 240 – T – M 25 – F – W 10 to 40	ETA-20/1119	9
horizontal	≥ 100 mm		X		25-40	EI	20	FP402	FP402 exposed face	EI 20 – T – X – F – W 25 to 40	ETA-20/1249	8
horizontal	≥ 100 mm		X		25-40	EI	45	FP402	FP402 unexposed face	EI 45 – T – X – F – W 25 to 40	ETA-20/1249	9
horizontal	≥ 100 mm		X		30-40	EI	20	FP404	FP404 fully filled	EI 20 – T – X – F – W 30 to 40	ETA-20/1118	7
horizontal	≥ 100 mm	X	X	25	30-40	EI	180	FP403	FP403 both faces	EI 180 – T – M 25 – F – W 30 to 40	ETA-20/1119	9
horizontal	≥ 100 mm		X		40	E	60	FP403	FP403 unexposed face	E 60 – T – X – F – W 40	ETA-20/1119	10
horizontal		X			5-50	EI	30	FP402	FP402 exposed face	EI 30 – T – X – F – W 5 to 50	ETA-20/1249	5
horizontal	≥ 150 mm	X	X		5-50	EI	30	FP403	FP403 exposed face	EI 30 – T – X – F – W 5 to 50	ETA-20/1119	11
horizontal		X			5-50	EI	60	FP402	FP402 unexposed face	EI 60 – T – X – F – W 5 to 50	ETA-20/1249	5
horizontal		X			5-50	EI	90	FP403	FP403 unexposed face	EI 90 – T – X – F – W 5 to 50	ETA-20/1119	6
horizontal		X			5-50	EI	120	FP403	FP403 exposed face	EI 120 – T – X – F – W 5 to 50	ETA-20/1119	6
horizontal		X			5-50	EI	180	FP402	FP402 both faces	EI 180 – T – X – F – W 5 to 50	ETA-20/1249	5
horizontal	≥ 100 mm		X		5-50	EI	240	FP402	FP402 both faces	EI 240 – T – X – F – W 5 to 50	ETA-20/1249	9
horizontal	≥ 150 mm	X	X		5-50	EI	240	FP403	FP403 both faces	EI 240 – T – X – F – W 5 to 50	ETA-20/1119	11
horizontal		X			5-50	E	180	FP403	FP403 exposed face	E 180 – T – X – F – W 5 to 50	ETA-20/1119	6



### STONE TO STONE WALL ≥ 100 MM

Orientation	Floor thickness	Valid for wall	Valid for wall abutting a floor	Movement	Joint width	E/EI	Minutes	Product	Application	Classification	ETA	ETA page
horizontal	≥ 150 mm	X	X		5-50	E	180	FP403	FP403 exposed face	E 180 – T – X – F – W 5 to 50	ETA-20/1119	11
horizontal	≥ 150 mm	X	X		5-50	E	240	FP402	FP402 both faces	E 240 – T – X – F – W 5 to 50	ETA-20/1249	9
horizontal		X			5-50	E	240	FP403	FP403 unexposed face	E 240 – T – X – F – W 5 to 50	ETA-20/1119	6

### STONE TO STONE WALL ≥ 115 MM

Orientation	Floor thickness	Valid for wall	Valid for wall abutting a floor	Movement	Joint width	E/EI	Minutes	Product	Application	Classification	ETA	ETA page
vertical		X			5	EI	180	FP403	FP403 unexposed face	EI 180 – V – X – F – W 5	ETA-20/1119	7
vertical		X			5	EI	240	FP401	FP401 unexposed face	EI 240 – V – X – F – W 5	ETA-20/1250	7
vertical		X			5	EI	240	FP402	FP402 unexposed face	EI 240 – V – X – F – W 5	ETA-20/1249	6
vertical		X			8	EI	120	FP404	FP404 fully filled	EI 120 – V – X – F – W 8	ETA-20/1118	5
vertical		X			8	EI	240	FP401 & FP404	FP401 unexposed face, FP404 exposed face	EI 240 – V – X – F – W 8	ETA-20/1250, 20/1118	7, 8
vertical		X			8	EI	240	FP402 & FP404	FP402 unexposed face, FP404 exposed face	EI 240 – V – X – F – W 8	ETA-20/1249, 20/1118	6, 8
vertical		X			8	EI	240	FP403 & FP404	FP403 unexposed face, FP404 exposed face	EI 240 – V – X – F – W 8	ETA-20/1119, 20/1118	7, 8
vertical		X			5-20	EI	45	FP401	FP401 unexposed face	EI 45 – V – X – F – W 5 to 20	ETA-20/1250	7
vertical		X			5-20	EI	60	FP403	FP403 unexposed face	EI 60 – V – X – F – W 5 to 20	ETA-20/1119	7
vertical		X			5-20	E	240	FP401	FP401 unexposed face	E 240 – V – X – F – W 5 to 20	ETA-20/1250	7
vertical		X			5-20	E	240	FP403	FP403 unexposed face	E 240 – V – X – F – W 5 to 20	ETA-20/1119	7
vertical		X			8-20	EI	60	FP404	FP404 fully filled	EI 60 – V – X – F – W 8 to 20	ETA-20/1118	5
vertical		X			5-25	EI	60	FP402	FP402 unexposed face	EI 60 – V – X – F – W 5 to 25	ETA-20/1249	6
vertical		X			5-25	E	240	FP402	FP402 unexposed face	E 240 – V – X – F – W 5 to 25	ETA-20/1249	6
vertical		X			8-25	EI	180	FP403 & FP404	FP403 unexposed face, FP404 exposed face	EI 180 – V – X – F – W 8 to 25	ETA-20/1119, 20/1118	7, 8
vertical		X			8-25	E	240	FP403 & FP404	FP403 unexposed face, FP404 exposed face	E 240 – V – X – F – W 8 to 25	ETA-20/1119, 20/1118	7, 8
vertical		X			5-30	EI	240	FP403	FP403 both faces	EI 240 – V – X – F – W 5 to 30	ETA-20/1119	7
vertical		X			5-30	E	240	FP403	FP403 both faces	E 240 – V – X – F – W 5 to 30	ETA-20/1119	7
vertical		X			8-30	EI	180	FP401 & FP404	FP401 unexposed face, FP404 exposed face	EI 180 – V – X – F – W 8 to 30	ETA-20/1250, 20/1118	7, 8
vertical		X			8-30	E	240	FP401 & FP404	FP401 unexposed face, FP404 exposed face	E 240 – V – X – F – W 8 to 30	ETA-20/1250, 20/1118	7, 8
vertical		X			20-30	EI	45	FP404	FP404 fully filled	EI 45 – V – X – F – W 20 to 30	ETA-20/1118	5
vertical		X			8-40	EI	180	FP402 & FP404	FP402 unexposed face, FP404 exposed face	EI 180 – V – X – F – W 8 to 40	ETA-20/1249, 20/1118	6, 8
vertical		X			8-40	E	240	FP402 & FP404	FP402 unexposed face, FP404 exposed face	E 240 – V – X – F – W 8 to 40	ETA-20/1249, 20/1118	6, 8

### STONE TO STONE WALL ≥ 150 MM

Orientation	Floor thickness	Valid for wall	Valid for wall abutting a floor	Movement	Joint width	E/EI	Minutes	Product	Application	Classification	ETA	ETA page
vertical		X			8-40	EI	45	FP404	FP404 fully filled	EI 45 – V – X – F – W 8 to 40	ETA-20/1118	5
vertical		X			8-50	EI	60	FP402 & FP404	FP402 exposed face, FP404 unexposed face	EI 60 – V – X – F – W 8 to 50	ETA-20/1249, 20/1118	7, 10
vertical		X			8-50	EI	60	FP403 & FP404	FP403 exposed face, FP404 unexposed face	EI 60 – V – X – F – W 8 to 50	ETA-20/1119, 20/1118	8, 10
horizontal	≥ 150 mm		X		10	EI	90	FP402	FP402 exposed face	EI 90 – T – X – F – W 10	ETA-20/1249	8
horizontal	≥ 150 mm		X		8-20	EI	120	FP404	FP404 fully filled	EI 120 – T – X – F – W 8 to 20	ETA-20/1118	7
horizontal	≥ 150 mm		X		20-30	EI	60	FP404	FP404 fully filled	EI 60 – T – X – F – W 20 to 30	ETA-20/1118	7
horizontal	≥ 150 mm		X		10-40	EI	45	FP402	FP402 exposed face	EI 45 – T – X – F – W 10 to 40	ETA-20/1249	8
horizontal	≥ 150 mm		X		10-40	E	120	FP402	FP402 exposed face	E 120 – T – X – F – W 10 to 40	ETA-20/1249	8
horizontal	≥ 150 mm		X		30-40	EI	45	FP404	FP404 fully filled	EI 45 – T – X – F – W 30 to 40	ETA-20/1118	7
horizontal	≥ 150 mm		X		40	EI	60	FP402	FP402 exposed face	EI 60 – T – X – F – W 40	ETA-20/1249	8
horizontal		X			5-50	EI	45	FP403	FP403 exposed face	EI 45 – T – X – F – W 5 to 50	ETA-20/1119	8
horizontal		X			5-50	EI	90	FP403	FP403 unexposed face	EI 90 – T – X – F – W 5 to 50	ETA-20/1119	8
horizontal		X			5-50	E	240	FP403	FP403 exposed face	E 240 – T – X – F – W 5 to 50	ETA-20/1119	8
horizontal		X			5-50	E	240	FP403	FP403 unexposed face	E 240 – T – X – F – W 5 to 50	ETA-20/1119	8

### STONE TO STONE WALL ≥ 200 MM

Orientation	Floor thickness	Valid for wall	Valid for wall abutting a floor	Movement	Joint width	E/EI	Minutes	Product	Application	Classification	ETA	ETA page
vertical		X			8-30	EI	120	FP404	FP404 fully filled	EI 120 – V – X – F – W 8 to 30	ETA-20/1118	5
vertical		X			30-40	EI	60	FP404	FP404 fully filled	EI 60 – V – X – F – W 30 to 40	ETA-20/1118	5
vertical		X			8-50	EI	45	FP402 & FP404	FP402 exposed face, FP404 unexposed face	EI 45 – V – X – F – W 8 to 50	ETA-20/1249, 20/1118	7, 10
vertical		X			8-50	EI	120	FP403 & FP404	FP403 exposed face, FP404 unexposed face	EI 120 – V – X – F – W 8 to 50	ETA-20/1119, 20/1118	8, 10

### STONE TO STEEL WALL ≥ 100 MM

Orientation	Floor thickness	Valid for wall	Valid for wall abutting a floor	Movement	Joint width	E/EI	Minutes	Product	Application	Classification	ETA	ETA page
vertical		X			5-20	EI	30	FP403	FP403 both faces	EI 30 – V – X – F – W 5 to 20	ETA-20/1119	12
vertical		X			5-20	E	120	FP403	FP403 both faces	E 120 – V – X – F – W 5 to 20	ETA-20/1119	12
vertical		X			20	EI	45	FP403	FP403 both faces	EI 45 – V – X – F – W 20	ETA-20/1119	12
vertical		X			20	EI	45	FP403	FP403 fully filled	EI 45 – V – X – F – W 20	ETA-20/1119	12
vertical		X			20	E	120	FP403	FP403 fully filled	E 120 – V – X – F – W 20	ETA-20/1119	12
horizontal		X			5-20	EI	45	FP403	FP403 both faces	EI 45 – T – X – F – W 5 to 20	ETA-20/1119	12
horizontal		X			5-20	E	120	FP403	FP403 both faces	E 120 – T – X – F – W 5 to 20	ETA-20/1119	12
horizontal		X			20	EI	60	FP403	FP403 both faces	EI 60 – T – X – F – W 20	ETA-20/1119	12
horizontal		X			20	EI	90	FP403	FP403 fully filled	EI 90 – T – X – F – W 20	ETA-20/1119	12
horizontal		X			20	E	120	FP403	FP403 fully filled	E 120 – T – X – F – W 20	ETA-20/1119	12

### STONE TO STEEL WALL ≥ 150 MM

Orientation	Floor thickness	Valid for wall	Valid for wall abutting a floor	Movement	Joint width	E/EI	Minutes	Product	Application	Classification	ETA	ETA page
vertical		X			5-20	EI	60	FP403	FP403 both faces	EI 60 – V – X – F – W 5 to 20	ETA-20/1119	12
vertical		X			5-20	E	120	FP403	FP403 both faces	E 120 – V – X – F – W 5 to 20	ETA-20/1119	12
horizontal		X			5-20	EI	90	FP403	FP403 both faces	EI 90 – T – X – F – W 5 to 20	ETA-20/1119	12
horizontal		X			5-20	E	120	FP403	FP403 both faces	E 120 – T – X – F – W 5 to 20	ETA-20/1119	12
horizontal		X			20	EI	120	FP403	FP403 both faces	EI 120 – T – X – F – W 20	ETA-20/1119	12

### STONE TO WOOD WALL ≥ 100 MM

Orientation	Floor thickness	Valid for wall	Valid for wall abutting a floor	Movement	Joint width	E/EI	Minutes	Product	Application	Classification	ETA	ETA page
vertical		X			5-20	EI	120	FP403	FP403 both faces	EI 120 – V – X – F – W 5 to 20	ETA-20/1119	12
vertical		X			5-20	E	120	FP403	FP403 both faces	E 120 – V – X – F – W 5 to 20	ETA-20/1119	12
vertical		X			8-20	EI	120	FP403 & FP404	FP403 unexposed face, FP404 exposed face	EI 120 – V – X – F – W 8 to 20	ETA-20/1119, 20/1118	14, 8
vertical		X			8-20	EI	120	FP404	FP404 fully filled	EI 120 – V – X – F – W 8 to 20	ETA-20/1118	5
vertical		X			8-20	E	120	FP403 & FP404	FP403 unexposed face, FP404 exposed face	E 120 – V – X – F – W 8 to 20	ETA-20/1119	14
horizontal		X			5-20	EI	120	FP403	FP403 both faces	EI 120 – T – X – F – W 5 to 20	ETA-20/1119	12
horizontal		X			5-20	E	120	FP403	FP403 both faces	E 120 – T – X – F – W 5 to 20	ETA-20/1119	12
horizontal		X			8-20	EI	90	FP404	FP404 fully filled	EI 90 – T – X – F – W 8 to 20	ETA-20/1118	6
horizontal		X			8-20	EI	120	FP403 & FP404	FP403 unexposed face, FP404 exposed face	EI 120 – T – X – F – W 8 to 20	ETA-20/1119, 20/1118	14, 8
horizontal		X			8-20	E	120	FP403 & FP404	FP403 unexposed face, FP404 exposed face	E 120 – T – X – F – W 8 to 20	ETA-20/1119	14
horizontal		X			20	E	240	FP403	FP403 both faces	E 240 – T – X – F – W 20	ETA-20/1119	12

### GYPSUM TO STONE WALL ≥ 75 MM

Orientation	Floor thickness	Valid for wall	Valid for wall abutting a floor	Movement	Joint width	E/EI	Minutes	Product	Application	Classification	ETA	ETA page
vertical		X			10	EI	60	FP403	FP403 both faces	EI 60 – V – X – F – W 10	ETA-20/1119	15
horizontal	not specified	X	X	25	10	EI	60	FP403	FP403 both faces	EI 60 – T – M 25 – F – W 10	ETA-20/1119	16
horizontal	not specified	X	X	25	10	EI	60	FP403	FP403 unexposed face	EI 60 – T – M 25 – F – W 10	ETA-20/1119	16

### GYPSUM TO STONE WALL ≥ 100 MM

Orientation	Floor thickness	Valid for wall	Valid for wall abutting a floor	Movement	Joint width	E/EI	Minutes	Product	Application	Classification	ETA	ETA page
vertical		X			10	EI	120	FP401	FP401 both faces	EI 120 – V – X – F – W 10	ETA-20/1250	9
vertical		X			10	E	180	FP401	FP401 both faces	E 180 – V – X – F – W 10	ETA-20/1250	9
vertical		X			10	EI	120	FP403	FP403 both faces	EI 120 – V – X – F – W 10	ETA-20/1119	15
horizontal		X			10	EI	120	FP401	FP401 both faces	EI 120 – T – X – F – W 10	ETA-20/1250	10
horizontal	not specified	X	X	25	10	EI	120	FP403	FP403 both faces	EI 120 – T – M 25 – F – W 10	ETA-20/1119	16
horizontal	not specified	X	X	25	10	EI	120	FP403	FP403 unexposed face	EI 120 – T – M 25 – F – W 10	ETA-20/1119	16
horizontal		X			10	E	180	FP401	FP401 both faces	E 180 – T – X – F – W 10	ETA-20/1250	10

### GYPSUM TO GYPSUM WALL ≥ 100 MM

Orientation	Floor thickness	Valid for wall	Valid for wall abutting a floor	Movement	Joint width	E/EI	Minutes	Product	Application	Classification	ETA	ETA page
vertical		X			10	EI	120	FP401	FP401 both faces	EI 120 – V – X – F – W 10	ETA-20/1250	9
vertical		X			10	EI	120	FP403	FP403 both faces	EI 120 – V – X – F – W 10	ETA-20/1119	15
vertical		X			10	E	180	FP401	FP403 both faces	E 180 – V – X – F – W 10	ETA-20/1250	9

### FLOOR ≥ 100 MM

Orientation	Floor thickness	Joint width	E/EI	Minutes	Product	Application	Classification	ETA	ETA page
floor	≥ 100 mm	8	EI	60	FP404	FP404 fully filled	EI 60 – H – X – F – W 8	ETA-20/1118	6
floor	≥ 100 mm	10	EI	90	FP402	FP402 exposed face	EI 90 – H – X – F – W 10	ETA-20/1249	7
floor	≥ 100 mm	10	EI	90	FP403	FP403 exposed face	EI 90 – H – X – F – W 10	ETA-20/1119	10
floor	≥ 100 mm	10	E	120	FP402	FP402 exposed face	E 120 – H – X – F – W 10	ETA-20/1249	7
floor	≥ 100 mm	10	EI	120	FP403	FP403 unexposed face	EI 120 – H – X – F – W 10	ETA-20/1119	10
floor	≥ 100 mm	10	EI	120	FP402	FP402 unexposed face	EI 120 – H – X – F – W 10	ETA-20/1249	8
floor	≥ 100 mm	8-20	EI	45	FP404	FP404 fully filled	EI 45 – H – X – F – W 8 to 20	ETA-20/1118	6
floor	≥ 100 mm	10-25	EI	30	FP402	FP402 exposed face	EI 30 – H – X – F – W 10 to 25	ETA-20/1249	7
floor	≥ 100 mm	10-25	E	60	FP402	FP402 exposed face	E 60 – H – X – F – W 10 to 25	ETA-20/1249	7
floor	≥ 100 mm	10-25	E	120	FP403	FP403 unexposed face	E 120 – H – X – F – W 10 to 25	ETA-20/1119	10
floor	≥ 100 mm	10-25	EI	90	FP402	FP402 unexposed face	EI 90 – H – X – F – W 10 to 25	ETA-20/1249	8
floor	≥ 100 mm	20-30	EI	30	FP404	FP404 fully filled	EI 30 – H – X – F – W 20 to 30	ETA-20/1118	6
floor	≥ 100 mm	25-40	EI	20	FP402	FP402 exposed face	EI 20 – H – X – F – W 25 to 40	ETA-20/1249	7
floor	≥ 100 mm	30-40	EI	20	FP404	FP404 fully filled	EI 20 – H – X – F – W 30 to 40	ETA-20/1118	6
floor	≥ 100 mm	10-40	EI	30	FP403	FP403 exposed face	EI 30 – H – X – F – W 10 to 40	ETA-20/1119	10
floor	≥ 100 mm	40	E	60	FP403	FP403 unexposed face	E 60 – H – X – F – W 40	ETA-20/1119	10
floor	≥ 100 mm	10-40	EI	60	FP403	FP403 unexposed face	EI 60 – H – X – F – W 10 to 40	ETA-20/1119	10
floor	≥ 100 mm	10-40	E	120	FP403	FP403 exposed face	E 120 – H – X – F – W 10 to 40	ETA-20/1119	10
floor	≥ 100 mm	10-40	E	120	FP402	FP402 unexposed face	E 120 – H – X – F – W 10 to 40	ETA-20/1249	8
floor	≥ 100 mm	25-40	EI	45	FP402	FP402 unexposed face	EI 45 – H – X – F – W 25 to 40	ETA-20/1249	8

### FLOOR ≥ 150 MM

Orientation	Floor thickness	Joint width	E/EI	Minutes	Product	Application	Classification	ETA	ETA page
floor	≥ 150 mm	10	EI	90	FP402	FP402 exposed face	EI 90 – H – X – F – W 10	ETA-20/1249	7
floor	≥ 150 mm	8-20	EI	120	FP404	FP404 fully filled	EI 120 – H – X – F – W 8 to 20	ETA-20/1118	6
floor	≥ 150 mm	20-30	EI	60	FP404	FP404 fully filled	EI 60 – H – X – F – W 20 to 30	ETA-20/1118	6
floor	≥ 150 mm	10-40	EI	45	FP402	FP402 exposed face	EI 45 – H – X – F – W 10 to 40	ETA-20/1249	7
floor	≥ 150 mm	30-40	EI	45	FP404	FP404 fully filled	EI 45 – H – X – F – W 30 to 40	ETA-20/1118	6
floor	≥ 150 mm	10-40	EI	60	FP402	FP402 exposed face	EI 60 – H – X – F – W 10 to 40	ETA-20/1249	7
floor	≥ 150 mm	40	EI	60	FP402	FP402 exposed face	EI 60 – H – X – F – W 40	ETA-20/1249	7
floor	≥ 150 mm	10-40	E	120	FP402	FP402 exposed face	E 120 – H – X – F – W 10 to 40	ETA-20/1249	7

# APPLICATION AREAS

EN 1366-4



**FP403 FIRESEAL HYBRID**  
1-COMPONENT, FIRE RESISTANT  
HYBRID BASED SEALANT



**FP401 FIRESEAL ACRYLIC**  
1-COMPONENT FIRE RESISTANT  
SEALANT BASED ON ACRYLIC  
DISPERSION



**FP404 FIRE RETARDANT PU FOAM**  
MODIFIED, 1-COMPONENT, FIRE  
RESISTANT POLYURETHANE FOAM



**FP402 FIRESEAL SILICONE**  
1-COMPONENT FIRE RESISTANT,  
NEUTRAL CURING SILICONE  
SEALANT



**FP404 FIRE RETARDANT  
PU GUNFOAM**  
MODIFIED, 1-COMPONENT,  
FIRE RESISTANT  
POLYURETHANE GUNFOAM



# PASSIVE FIRE PROTECTION

- SAVES LIVES
- LIMITS MATERIAL DAMAGE LOSS
- MINIMISES BUSINESS LOSS
- PROTECTS THE BUILDING, WHICH MEANS IT IS ACCESSIBLE AFTER THE FIRE



# FIRE PROTECT

## SERVICE PENETRATIONS (EN 1366-3)

**A fire compartment consists of fire resistant walls and floors. These walls and floors have openings through which pipes and electricity cables are transmitted.**

A fire compartment is not complete until these openings have been sealed safely using the correct materials. Products and systems tested in accordance with 1366-3 are used to seal openings and thus to ensure that the compartments are sufficiently fire resistant despite the openings for electricity cables and mechanical installations.

Modern buildings are packed full of services, cables and wires. Where these services penetrate fire resisting elements of the building there remains a weakness in the fire protection for that building.

These penetrations must therefore be correctly sealed in order to maintain the buildings fire resistance levels. There are many factors to take into consideration when finding the correct solution to sealing service penetrations. Every service passing through fire resisting building elements reacts differently when there is a fire. There is therefore no single solution or product that can be used to effectively protect all service penetrations.

The fire resistant properties of our solutions have been tested in accordance with international standards by certified organisations (notified bodies). The results of these tests are summarised in international certificates. All our products and their comprehensive range of applications are CE marked and each have an ETA (European Technical Assessment). These specially developed products can be used separately, but combinations of products have also been tested. This enables us to provide a solution for almost every situation.



# PRODUCT PORTFOLIO

## SERVICE PENETRATIONS (EN 1366-3)

Our solutions for service penetrations consist of:

- BOSTIK FP310 INTUMESCENT ACOUSTIC ACRYLIC
- BOSTIK FP311 INTUMESCENT GRAPHITE
- BOSTIK FP312 FIRE RETARDANT COATING
- BOSTIK FP320 FIRE BATT
- BOSTIK FP330 PIPE COLLAR
- BOSTIK FP340 PIPE WRAP
- BOSTIK FP350 GRAPHITE PLATE
- BOSTIK FP360 PUTTY CORD
- BOSTIK FP370 FIRESEAL MORTAR

FIRE PROTECT

# FP310 INTUMESCENT ACOUSTIC ACRYLIC

**A FIRE RATED SINGLE COMPONENT ACRYLIC SEALANT SPECIALLY DESIGNED TO PREVENT THE SPREAD OF FIRE AND SMOKE THROUGH JOINTS AND OPENINGS IN FIRE RATED WALLS AND FLOORS INCLUDING OPENINGS FORMED AROUND BUILDING SERVICE PENETRATIONS.**

Expands when heated and produces an efficient seal against fire, smoke and gas. When subjected to atmospheric conditions, the sealant cures and will retain a degree of elasticity for joint movement. Under fire exposure, Bostik FP310 Intumescent Acoustic Acrylic creates a robust fire seal by the formation of a durable intumescent char and prevent the passage of fire and smoke for periods up to 4 hours. Offers a very good sound insulation. Bostik FP310 Intumescent Acoustic Acrylic is tested with many different types of penetrations through many different constructions.



Consult the Technical Data Sheet for more information. Examples of applications of the BOSTIK FP310 INTUMESCENT ACOUSTIC ACRYLIC are shown on the right side of this page. For all certified applications please view the Application Guidelines. Always consult the ETA prior to application to ensure to achieve the intended fire resistance.



### Most important characteristics

- Certified to the latest European standards EN 1366-3 and EN 1366-4
- Fire resistance up to 4 hour
- Joint movement up to 12,5%
- Very high sound insulation
- Easy to apply with a smooth surface finish
- Paintable with most water based and alkyd paints
- Easy to clean
- Hardens quickly, tack free after 1 hour
- 18 months storage time (under correct conditions)

### Certificates / testreports

- ETA 21/0550 & ETA 21/0552
- CE certificate 0843-CPR-0517
- DoP-number 614486-21-08-1
- UL-EU
- Sound insulation tested to ISO 10140-2:2010, seal ≥12mm depth: Rw 62 dB
- A+ French VOC Regulation
- Emission EC1Plus
- Eurofins IAC Gold
- Der Blaue Engel
- BREEAM
- LEED certification
- Fire class B-s1,d0 according to EN 13501-1

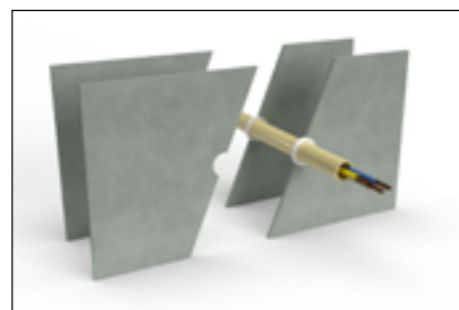
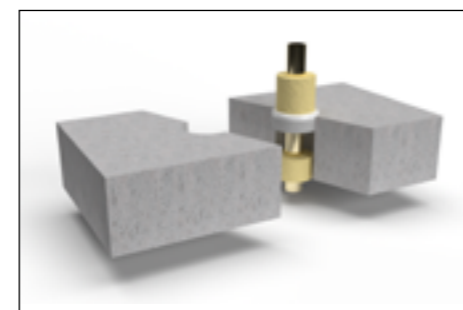

Article number	EAN code	Colour	Packaging	Packed per
30614486	8713572041594	white	cartridge 310ml	12 pieces in a box
30615383	8713572042485	white	sausage 600 ml	12 pieces in a box

# FP311 INTUMESCENT GRAPHITE

**A HIGH SPECIFICATION FORMULATION DESIGNED TO PREVENT THE SPREAD OF FIRE, SMOKE AND GASES THROUGH OPENINGS IN FIRE RATED WALLS AND FLOORS.**

Bostik FP311 Intumescent Graphite is a single component, water based, fire retardant sealing compound which contains a high concentration of heat expanding graphite material. Bostik FP311 Intumescent Graphite expands when it is subjected to fire and closes openings around combustible pipes (e.g. PVC) or metal pipes fitted with combustible insulation. Bostik FP311 Intumescent Graphite offers a very good sound insulation. Bostik FP311 Intumescent Graphite is designed to fire seal difficult services which traditional fire rated mastics do not achieve such as large plastic pipes.



Consult the Technical Data Sheet for more information. Examples of applications of the BOSTIK FP311 INTUMESCENT GRAPHITE are shown on the right side of this page. For all certified applications please view the Application Guidelines. Always consult the ETA prior to application to ensure to achieve the intended fire resistance.



### Most important characteristics

- Certified to the latest European standards EN 1366-3
- Fire resistance up to 4 hour
- Classified in most constructions for plastic pipes and cables
- Suitable for most surfaces, included concrete, bricks, steel, wood, gypsum, PVC and most non-porous surfaces
- High sound insulation
- Easy to apply
- Fast curing, tack free after 1 hour
- Paintable with most water based and alkyd paints
- 18 months storage time (under correct conditions)

### Certificates / testreports

- ETA 21/0556
- CE certificate 0843-CPR-0518
- DoP-number 614867-21-08-1
- UL-EU
- Sound insulation tested to ISO 10140-2:2010, seal ≥25mm depth: Rw 53 dB
- A+ French VOC Regulation
- Emission EC1Plus
- Eurofins IAC Gold
- Der Blaue Engel
- BREEAM
- LEED certification
- Fire class B-s1,d0 according to EN 13501-1

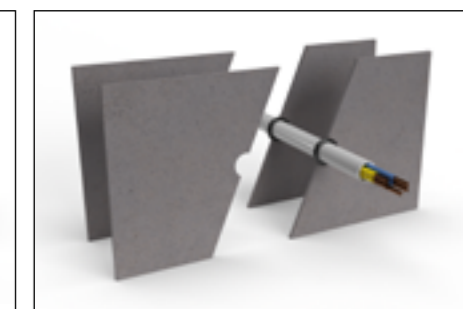
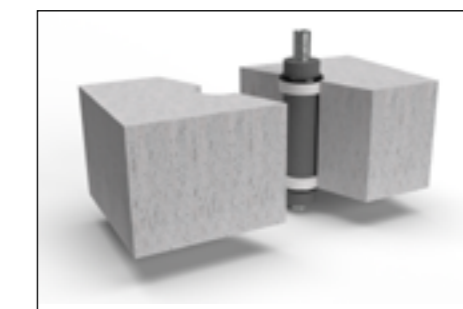

Article number	EAN code	Colour	Packaging	Packed per
30614867	8713572041600	anthracite	cartridge 310ml	12 pieces in a box

# FP312 FIRE RETARDANT COATING

**A SPRAYABLE ABLATIVE COATING SPECIALLY DESIGNED TO ENHANCE, SEAL AND FIRE PROTECT STONE WOOL FIBRES.**

The coating dries to give a flexible white surface finish. Stone wool fibres coated with Bostik FP312 Fire Retardant Coating prevent the spread of fire and smoke through openings in fire rated walls and floors where openings are formed to allow the installation of multiple building services. The system will contribute maintaining the acoustic design performance.



Consult the Technical Data Sheet for more information. Examples of applications of the BOSTIK FP312 FIRE RETARDANT COATING are shown on the right side of this page. For all certified applications please view the Application Guidelines. Always consult the ETA prior to application to ensure to achieve the intended fire resistance.

#### Most important characteristics

- Certified to the latest European standard EN 1366-3 & 4
- Fire resistance up to 4 hour
- Permanently flexible - will accommodate movements during fire and smaller movements in the construction it has been fitted within
- Easy and very quick to apply
- The coating applied on stone wool fibres is classified for all types of constructions with or without building service penetrations
- May be used in unlimited lengths in walls with heights up to 1200mm and in floors with widths up to 120mm
- May be installed in gypsum walls without framing around the opening
- Paintable with most water based and alkyd paints
- Easy to clean
- Once fully cured, resistant of water and frost

#### Certificates / testreports

- ETA 21/0553 & ETA 21/0555
- CE certificate 0843-CPR-0519
- DoP-number 614868-21-08-1
- Sound insulation tested to ISO 10140-2:2010, 1.00 film thickness on both sides of minimum 50 mm thick stone wool with density minimum 160 kg/m<sup>3</sup>: Rw 55 dB
- A+ French VOC Regulation
- Eurofins IAC
- Complies with requirements of M1 Protocol
- LEED certification

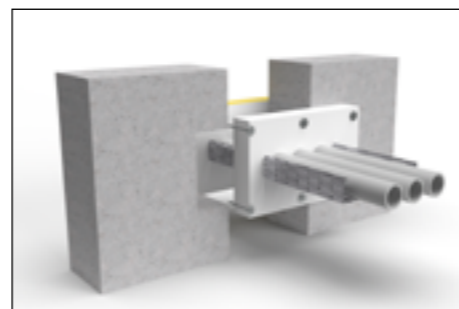
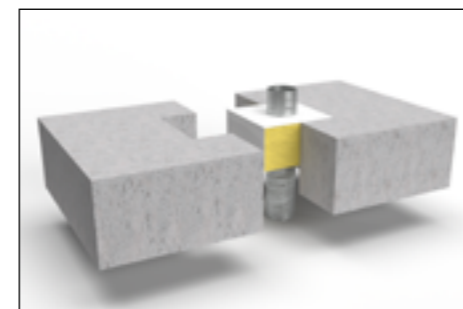

Article number	EAN code	Colour	Packaging	Packed per
30614868	8713572041617	white	pail 8 ltr	pail

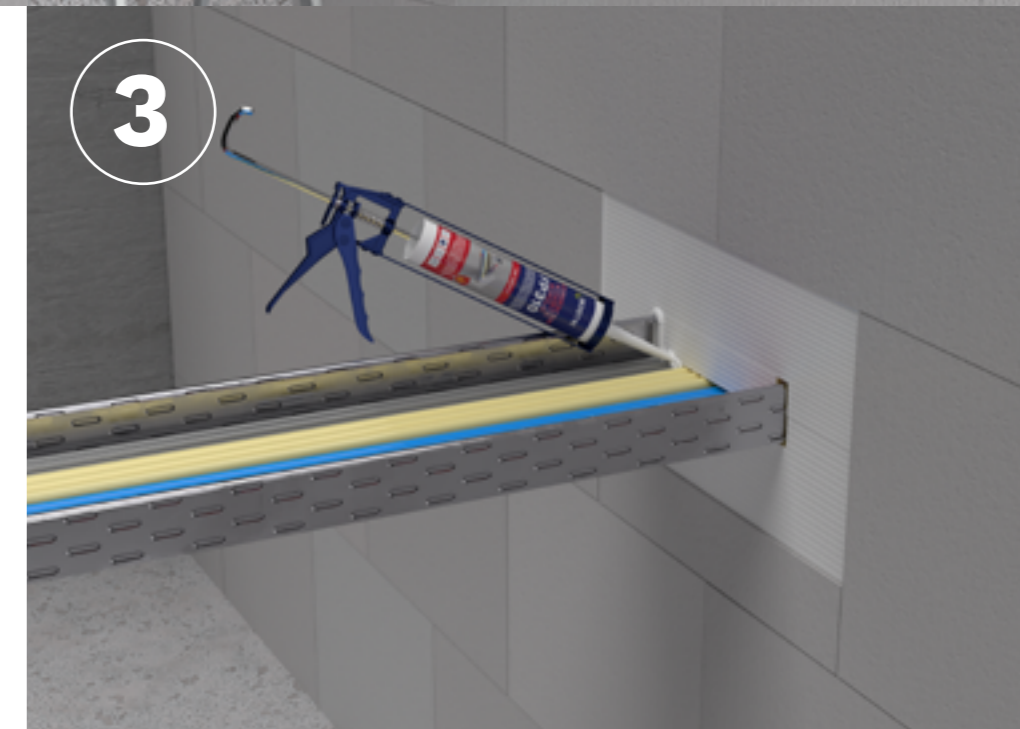
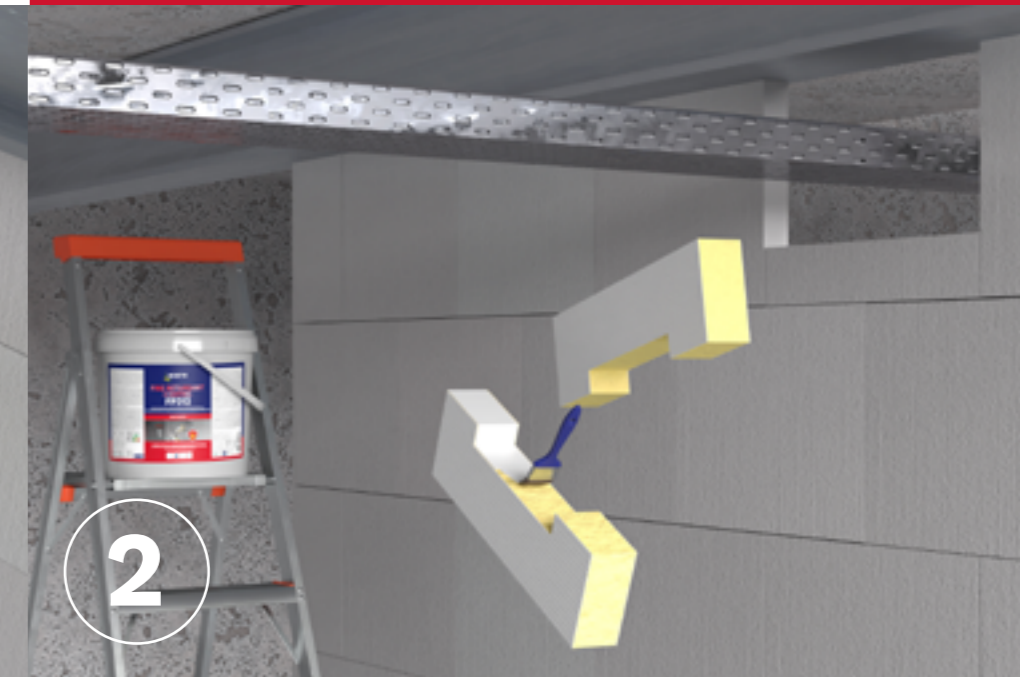
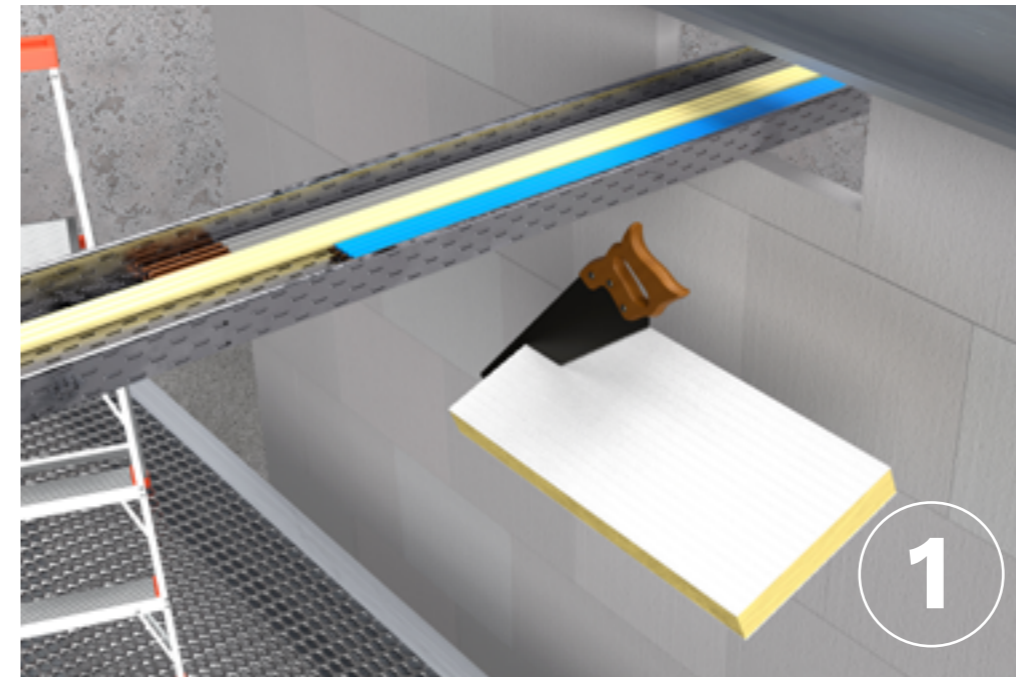

## FIRE PROTECTION CABLE TRAY SEALING

**THE FIRE PROTECT PORTFOLIO HOLDS SEVERAL PRODUCTS THAT ARE ESPECIALLY DEVELOPED FOR USE IN CABLE TRAY SEALING**

- 1 BOSTIK FP320 FIRE BATT
- 2 BOSTIK FP312 FIRE RETARDANT COATING
- 3 BOSTIK FP311 INTUMESCENT ACOUSTIC ACRYLIC



# FP320 FIRE BATT

**A HIGH DENSITY STONE WOOL BOARD OVER-COATED WITH BOSTIK FP 312 FIRE RETARDANT COATING, DESIGNED TO MAINTAIN THE FIRE RESISTANCE OF SEPARATING WALLS AND FLOORS WHERE THEY ARE BREACHED BY SINGLE OR MULTIPLE BUILDING SERVICES.**

The top coating provides additional protection by significantly reducing the permeability of the stone wool core and prevents the passage of hot gases, thus reducing the temperature rise on the unexposed side and reducing heat conduction through building services. On site, Bostik FP320 Fire Batt must be used together with Bostik FP310 Intumescent Acrylic for sealing around building services and the surrounding construction.

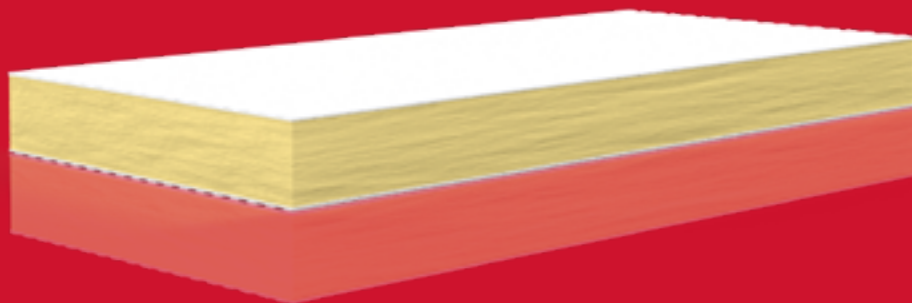

Consult the Technical Data Sheet for more information. Examples of applications of the BOSTIK FP320 FIRE BATT are shown on the right side of this page. For all certified applications please view the Application Guidelines. Always consult the ETA prior to application to ensure to achieve the intended fire resistance.

### Most important characteristics

- Certified to the latest European standards EN 1366-3
- Classified for all types of constructions with or without building service penetrations
- Simple and very quick to install
- Permanently flexible, will accommodate movements during fire and smaller movements in the construction it has been fitted within
- Suitable for most surfaces, including concrete, bricks, masonry, steel, wood, gypsum board, glass, plastic and most non-porous surfaces
- May be used in unlimited lengths in walls with heights up to 1200mm and in floors with widths up to 800mm
- May be installed in gypsum walls with or without framing around the opening
- Paintable with most water based and synthetic paints
- Once fully cured, the batt resists UV, humidity and frost
- Unlimited storage time (under correct conditions)
- Halogen free with added fungicides

### Certificates / testreports

- ETA 21/0549
- CE certificate 0843-CPR-0520
- DoP-number 614782-21-08-1
- UL-EU
- Sound insulation tested to ISO 10140-2:2010, single 50 mm Bostik FP320 Fire Batt: Rw 55 dB
- A+ French VOC Regulation
- Eurofins IAC
- M1 certificate
- LEED certification

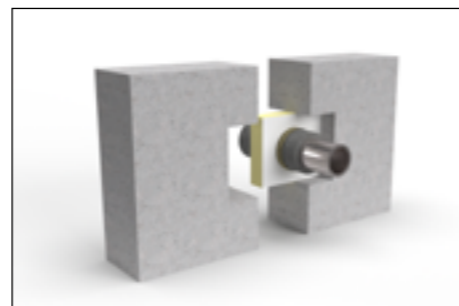
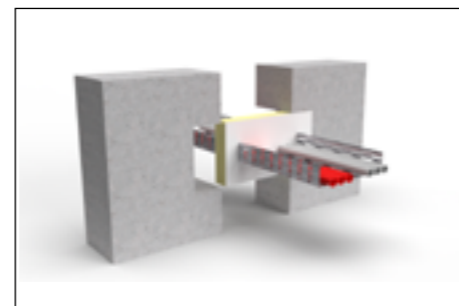

Article number	EAN code	Colour	Packaging	Packed per
30614782	8713572041624	white	50mmx60cmx120cm	1 piece in foil
30616370	8713572042904	white	60mmx60cmx120cm	1 piece in foil

# FP330 PIPE COLLAR

**A FIRE COLLAR WHICH EXPANDS IN THE CASE OF A FIRE TO FILL VOIDS LEFT BY MELTING PLASTIC AND BURNING OF COMBUSTIBLE PIPE INSULATION.**

Bostik FP330 Pipe Collar consists of a split white coated, circular steel casing designed to fit around plastic pipes. The collars have a secure and simple locking device. The steel sleeve contains a graphite based expanding material which on exposure to heat fills voids left by combustible pipes and pipe insulation passing through fire walls and floors.

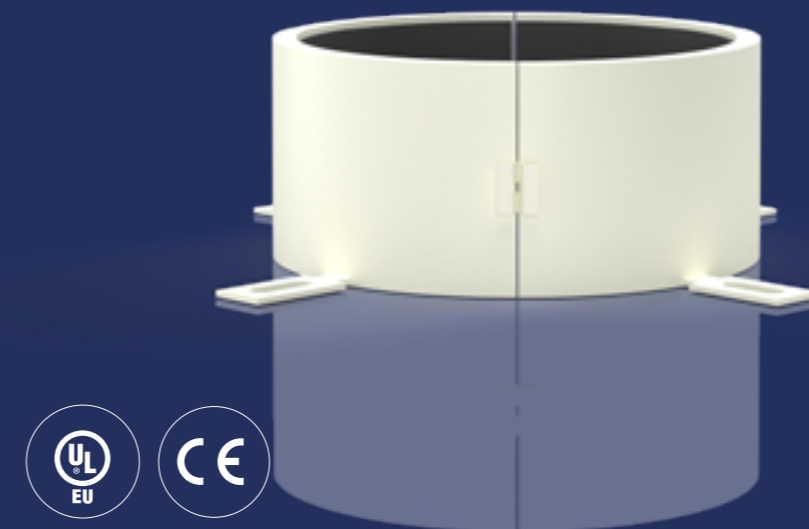

Consult the Technical Data Sheet for more information. Examples of applications of the BOSTIK FP330 PIPE COLLAR are shown on the right side of this page. For all certified applications please view the Application Guidelines. Always consult the ETA prior to application to ensure to achieve the intended fire resistance.

### Most important characteristics

- Certified to the latest European standards EN 1366-3
- Fire resistance up to 4 hours for both integrity and insulation
- Fast expanding graphite material
- Classified for fire sealing all types of constructions and many different building service penetrations including plastic pipes, composite pipes, metal pipes and cable bundles
- Approved plastic pipe sizes range from smallest pipes available to Ø 315mm, each with a wide range of pipe wall thicknesses
- Collars are available in two different heights for different fire classifications to maximize cost efficiency
- Smaller pipes can be fitted within larger collars with the benefit of accommodating pipes that are at an angle or if the opening around the pipe is too large
- Tested and certified for U/U pipe end applications
- No emissions, environmental and user friendly
- Very easy to install using widely available standard fixings
- Excellent sound insulation
- Unlimited storage time (under correct conditions)

### Certificates / testreports

- ETA 21/0551
- CE certificate 0843-CPR-0521
- DoP-number 614856-21-08-1
- UL-EU
- Sound insulation tested to ISO 10140-2:2010, Bostik FP330 Pipe Collar in walls: Rw 58 dB

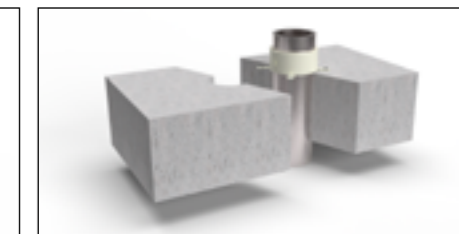
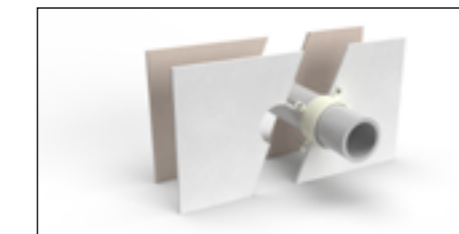

Article number	EAN code	Colour	Packaging	Packed per
30619141	8713572043185	white	Ø55/50mm	24 pieces in a box
30614856	8713572041631	white	Ø75/30mm	24 pieces in a box
30615019	8713572042331	white	Ø75/50mm	24 pieces in a box
30614857	8713572041648	white	Ø82/30mm	24 pieces in a box
30615018	8713572042348	white	Ø82/50mm	24 pieces in a box
30614858	8713572041655	white	Ø110/30mm	24 pieces in a box
30615017	8713572042355	white	Ø110/50mm	24 pieces in a box
30614859	8713572041662	white	Ø125/60mm	20 pieces in a box
30614860	8713572042218	white	Ø160/60mm	12 pieces in a box
30614861	8713572042225	white	Ø200/60mm	2 pieces in a box
30614862	8713572042232	white	Ø250/75mm	2 pieces in a box
30623632	8711595225830	white	Ø315/75mm	2 pieces in a box

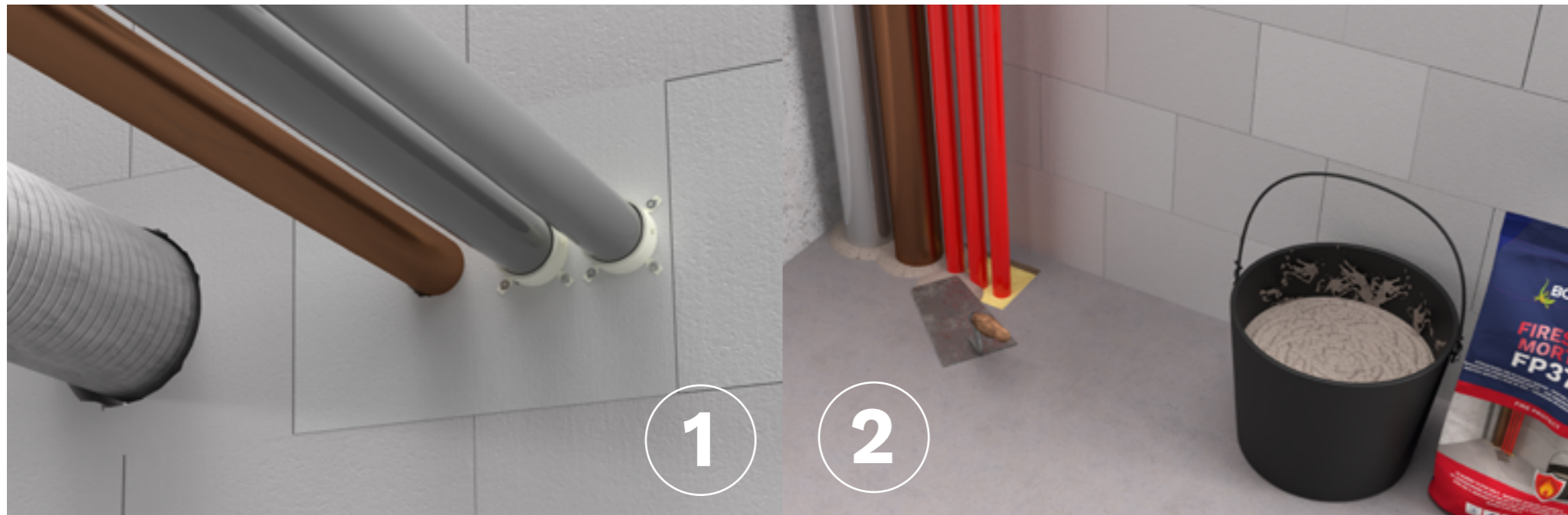

1

2

3

## FIRE PROTECTION PIPE SEALING

THE FIRE PROTECT PORTFOLIO HOLDS SEVERAL PRODUCTS THAT ARE ESPECIALLY DEVELOPED FOR USE IN PIPE SEALING AND OTHER SERVICE PENETRATIONS IN FIRE PROOF CONSTRUCTIONS.

- 1 BOSTIK FP330 PIPE COLLAR
- 2 BOSTIK FP370 FIRESEAL MORTAR
- 3 BOSTIK FP360 PUTTY CORD

## FP340 PIPE WRAP

A FLEXIBLE SLEEVE WHICH EXPANDS VASTLY IN CASE OF FIRE. EACH PIPE WRAP CONSISTS OF A GRAPHITE BASED REACTIVE INTUMESCENT STRIP, WHICH REACTS TO HEAT AND CLOSES THE OPENING LEFT BY THE SOFTENING PLASTIC PIPE OR COMBUSTIBLE PIPE INSULATION IN A FIRE.

The pipe wrap is installed completely around the pipes or insulation and secured with the self-adhesive tape. The annular space around the pipe wrap is sealed with Bostik FP320 Fire Batt and Bostik FP310 Intumescent Acrylic.

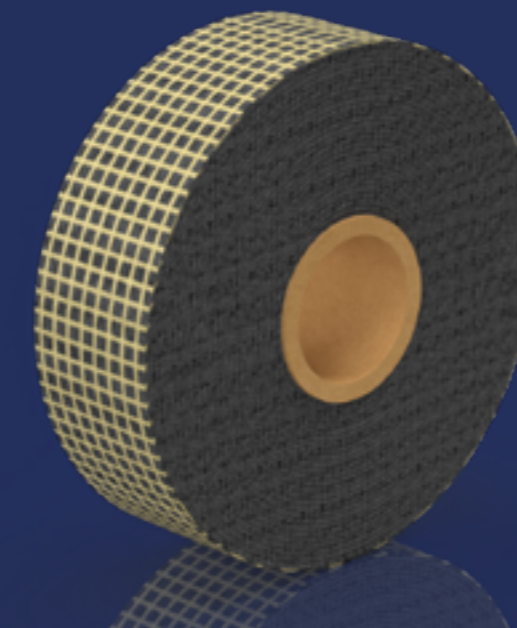

Consult the Technical Data Sheet for more information. Examples of applications of the BOSTIK FP340 PIPE WRAP are shown on the right side of this page. For all certified applications please view the Application Guidelines. Always consult the ETA prior to application to ensure to achieve the intended fire resistance.

### Most important characteristics

- Certified to the latest European standards EN 1366-3
- Fire resistance up to 4 hours for both integrity and insulation
- For plastic pipes and metal pipes with continuous combustible pipe insulation
- For plastic pipes with cables (conduits)
- Certified for PVC-U, PVC-C, PE (LD-PE, MD-PE, HD-PE), ABS, SAN+PVC and PP pipes
- Tested and certified for U/U pipe end applications
- Classified for fire sealing in all types of constructions
- No emissions, environmental and user friendly
- Very easy to install
- Very good sound insulation
- Not paintable
- Unlimited storage time (under correct conditions)

### Certificates / testreports

- ETA 21/0625
- CE certificate 0843-CPR-0522
- DoP-number 614856-21-08-1
- UL-EU
- Sound insulation tested to ISO 10140-2:2010, Bostik FP340 Pipe Wrap installed in Bostik FP320 Fire Batt: Rw 55 dB, Bostik FP340 Pipe Wrap installed in Bostik FP370 Fireseal Mortar: Rw 64 dB

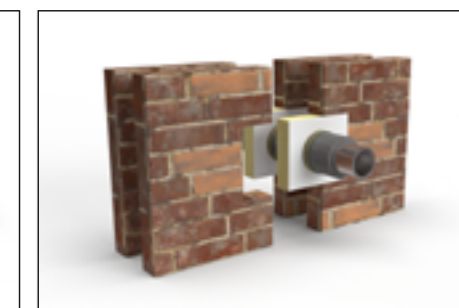
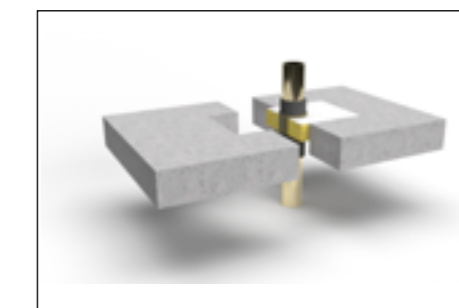

Article number	EAN code	Colour	Packaging	Packed per
30614863	8713572041679	white	Ø55mm	25 pieces in a box
30614864	8713572041686	white	Ø82mm	25 pieces in a box
30614865	8713572041693	white	Ø110mm	25 pieces in a box
30614866	8713572041709	white	Ø125mm	20 pieces in a box
30615057	8713572042393	black	50mmx25m	1 piece in a box
30615056	8713572042409	black	75mmx25m	1 piece in a box

# FP350 GRAPHITE PLATE

**A PRE-FORMED SELF-ADHESIVE INTUMESCENT PLATE USED TO REINSTATE THE FIRE RESISTANCE PERFORMANCE OF FLEXIBLE WALL CONSTRUCTIONS WHERE THEY ARE PENETRATED BY PLASTIC WALL / SOCKET BOXES.**

Bostik FP350 Graphite Plate immediately reacts to fire through heat and rapidly expands and fills the box, limiting fire and smoke from passing through. It is also tested with cable and conduits connected to the socket box to prevent the passage of smoke and fire through the electrical conduits between socket boxes. Bostik FP350 Graphite Plate will reinstate the fire resistance performance of flexible wall constructions for up to 120 minutes.



#### Most important characteristics

- Certified to the latest European standards EN 1366-3
- Fast expanding graphite material
- For flexible walls with a minimum thickness of 75 mm
- Can be used on insulated and uninsulated walls
- Tested with a wide range of cables and conduits interconnected between boxes
- Tested with empty conduits between boxes for future cable transits
- Very quick and easy to install
- Ready to fit
- Unlimited storage time (under correct conditions)

#### Certificates / testreports

- ETA 21/0554
- CE certificate 0843-CPR-0523
- DoP-number 615087-21-08-1

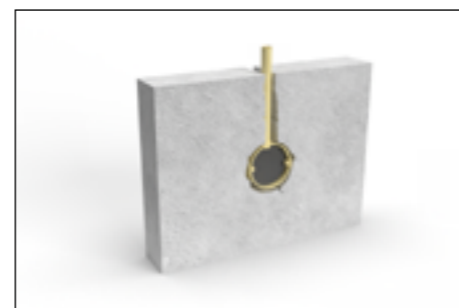

Article number	EAN code	Colour	Packaging	Packed per
30615087	8713572041723	grey	45 x 45mm	10 pieces in a box
30615086	8713572041730	grey	Ø59mm	10 pieces in a box

# FP360 PUTTY CORD

**A SILICON BASED FIRE RATED PUTTY, HAND WORKABLE, RE-USABLE AND RE-SERVICEABLE DUE TO ITS NON-SETTING PROPERTIES.**

Bostik FP360 Putty Cord contains a low pressure intumescent for optimal fire protection. Bostik FP360 Putty Cord is designed to be easily fitted around service penetrations where the gap around the services is very small, or there is no gap at all so a conventional fire rated sealant is impossible or difficult to fit due to the required depth and backing material. The putty cords are fitted covering the gap around the services and does not need to fill the gap to the required depth. Bostik FP360 Putty Cord will reinstate the fire rating of the partition and prevent the passage of smoke and flames in a fire, whilst also limiting sound and air movement around the service.



Consult the Technical Data Sheet for more information. Examples of applications of the BOSTIK FP360 PUTTY CORD are shown on the right side of this page. For all certified applications please view the Application Guidelines. Always consult the ETA prior to application to ensure to achieve the intended fire resistance.

#### Most important characteristics

- Certified to the latest European standards EN 1366-3
- Fire resistance up to 120 minutes for both integrity and insulation
- Fire sealing without any minimum annular width around services
- For cables, steel pipes, copper pipes and alupex pipes
- Gives service penetrations a high fire resistance in dry lining partitions and masonry or concrete walls and floors
- Stops penetration of both cold and hot smoke
- Self-adhesive and very easy to apply without tools
- Unaffected by moisture: can be used in wet rooms
- Never hardens and ensures a tight fit
- Can be reshaped in other sizes if necessary
- Environment- and user friendly, contains no solvents or VOC's
- Very easy to install

#### Certificates / testreports

- ETA 21/0557
- CE certificate 0843-CPR-0524
- DoP-number 615327-21-08-1
- UL-EU
- A+
- EC1Plus
- Eurofins IAC Gold
- BREEAM
- LEED Certificate

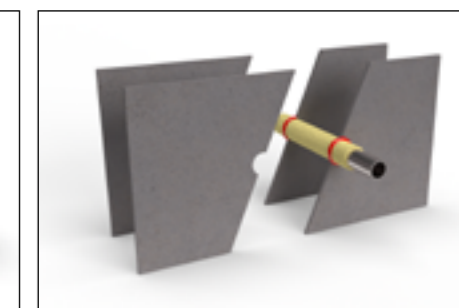
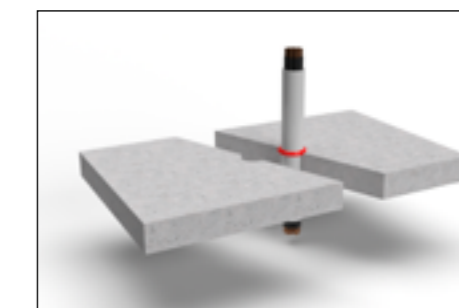

Article number	EAN code	Colour	Packaging	Packed per
30615327	8713572041747	red	20cm length	5 pieces in a box

# FP370 FIRESEAL MORTAR

**A DRY WHITE POWDER CONSISTING OF INORGANIC COMPOUNDS AND PERLITE.**

When mixed with water, the compounds form a highly thermally insulating fire sealing compound to prevent the spread of fire and smoke through openings in fire rated walls and floors, including openings formed around building service penetrations. Bostik FP370 Fireseal Mortar expands approx. 1% by hydraulic action during curing ensuring a very tight seal around the service penetrations and the surrounding opening apertures. Bostik FP370 Fireseal Mortar is easy to sand or drill. The compound dries to an off-white colour which may be painted if required. Bostik FP370 Fireseal Mortar will also maintain the acoustic design performance in walls and floors.



Consult the Technical Data Sheet for more information. Examples of applications of the BOSTIK FP370 FIRESEAL MORTAR are shown on the right side of this page. For all certified applications please view the Application Guidelines. Always consult the ETA prior to application to ensure to achieve the intended fire resistance.

#### Most important characteristics

- Certified to the latest European standard EN 1366-3
- Fire resistance up to 4 hour
- The fire performance specification of the compound has been derived when the seal has been left to cure for 1 month
- Classified in walls and floors of concrete, brick, gypsum etc.
- Suitable for cables, bundled cables, cable racks, cable trays, steel, copper, alupex, plastic pipes and air ventilation ducts
- High degree of mechanical resistance; the seal is load bearing without reinforcement
- No priming necessary prior to application in most building material substrates however metal services in contact with the seal must be corrosion protected
- Suitable for most surfaces, included concrete, bricks, Leca, steel, plastic etc., but not suitable to fitting of doors or in service openings that involve movement
- The product is certified for use in walls but it is recommended to use Bostik FP320 Fire Batts for these applications
- Easy to apply leaving a very smooth finish
- Fully set within 1 hour

#### Certificates / testreports

- ETA
- CE certificate 0843-CPR-0525
- DoP-number 615213-21-08-1
- UL-EU
- Sound insulation tested to ISO 10140-2:2010, Single sided cast  $\geq 50$  mm thick as linear seal: Rw 64 Db, Double sided cast  $\geq 25$  mm thick as linear seal: Rw 64 dB, Single sided cast  $\geq 50$  mm thick as large seal: Rw 48 dB, Double sided cast  $\geq 25$  mm thick as large seal: Rw 48 dB
- A+ French VOC Regulation
- Emission EC1Plus
- Eurofins IAC Gold
- Der Blaue Engel
- BREEAM

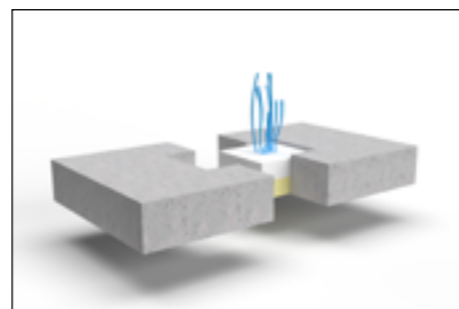
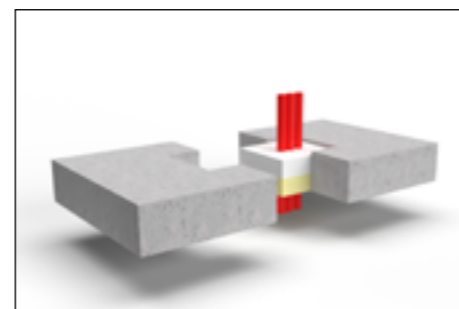

Article number	EAN code	Colour	Packaging	Packed per
30615213	8713572042270	white	15 kg	bag

# PRODUCT SELECTOR SERVICE PENETRATIONS

Seal size	Construction	Services	Bostik Products
Gap between 0 and 10mm	Walls and floors	Cables	FP360 Putty Cord
		Metal pipes; un-insulated or mineral wool insulations	
		Metal pipes; combustible insulations	FP330 Pipe Collar
Gap between 10 and 30mm	Walls and floors	Plastic pipes	
		Cables	FP310 Intumescent Acoustic Acrylic
		Metal pipes; un-insulated or mineral wool insulations	
		Metal pipes; combustible insulations	FP310 Intumescent Acoustic Acrylic, FP311 Intumescent Graphite
Gap above 300 mm and mixed services	Walls	Plastic pipes	FP310 Intumescent Acoustic Acrylic, FP311 Intumescent Graphite or FP330 Pipe Collar
		Cables and cable trays	FP320 Fire Batt
		Metal pipes; un-insulated or mineral wool insulations	
	Floors	Metal pipes; combustible insulations	FP320 Fire Batt & FP340 Pipe Wrap
		Plastic pipes	FP370 Fireseal Mortar
Floors	Floors	Metal pipes; un-insulated or mineral wool insulations	FP370 Fireseal Mortar &
		Metal pipes; combustible insulations	FP370 Fireseal Mortar & FP340 Pipe Wrap

\* Before application consult the ETA and installation instructions to ensure to achieve the intended fire resistance.

FIRE PROTECT



Type of penetration	Seals without penetrations						Cables						
SIZES	30mm	50mm	100mm	300x300mm	1200x2400mm	1200x∞mm	≤Ø21mm single	≤Ø21mm bundled	≤Ø50mm single	≤Ø50mm bundled	≤Ø80mm single	≤Ø80mm bundled	Trays & ladders
<b>FP310 INTUMESCENT ACOUSTIC ACRYLIC</b>	✓	✓	✓	✓	✗	✗	✓	✓	✓	✓	✓	✓	✗
<b>FP311 INTUMESCENT GRAPHITE</b>	✗	✗	✗	✗	✗	✗	✓	✗	✗	✗	✗	✗	✓
<b>FP320 FIRE BATT</b>	✓	✓	✓	✓	✓	✓	✓	✓	✓	✓	✓	✓	✓
<b>FP330 PIPE COLLAR</b>	✗	✗	✗	✗	✗	✗	✗	✗	✗	✗	✗	✗	✗
<b>FP340 PIPE WRAP</b>	✗	✗	✗	✗	✗	✗	✗	✗	✗	✗	✗	✗	✗
<b>FP360 PUTTY CORD</b>	✗	✗	✗	✗	✗	✗	✓	✓	✓	✓	✓	✗	✗
<b>FP370 FIRESEAL MORTAR</b>	✓	✓	✓	✓	✓	✗	✓	✓	✓	✓	✓	✓	✓

Pipes	Steel	Copper	Alupex	Plastic							
SIZES	Without insulation ≤Ø 325mm	Without insulation ≤Ø 54mm	Without insulation ≤Ø 75mm	≤Ø 32mm	≤Ø 40mm	≤Ø 75mm	≤Ø 110mm	≤Ø 160mm	≤Ø 400mm	Conduits	PEX pipe-in-pipe
<b>FP310 INTUMESCENT ACOUSTIC ACRYLIC</b>	✓	✓	✓	✓	✓	✓	✗	✗	✗	✓	✓
<b>FP311 INTUMESCENT GRAPHITE</b>	✗	✗	✗	✗	✓	✓	✓	✗	✗	✓	✗
<b>FP320 FIRE BATT</b>	✓	✓	✓	✓	✓	✓	✓	✓	✓	✓	✓
<b>FP330 PIPE COLLAR</b>	✗	✗	✗	✗	✓	✓	✓	✓	✓	✗	✗
<b>FP340 PIPE WRAP</b>	✗	✓	✗	✓	✓	✓	✓	✓	✓	✓	✓
<b>FP360 PUTTY CORD</b>	✓	✓	✓	✓	✓	✗	✗	✗	✗	✗	✗
<b>FP370 FIRESEAL MORTAR</b>	✓	✓	✓	✓	✓	✓	✓	✓	✓	✓	✓

# APPLICATION AREAS

## EN 1366-3



**FP310 INTUMESCENT ACOUSTIC ACRYLIC**  
A FIRE RATED SINGLE COMPONENT ACRYLIC SEALANT

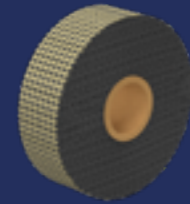

**FP340 PIPE WRAP**  
FLEXIBLE SLEEVE THAT EXPANDS VASTLY IN CASE OF FIRE

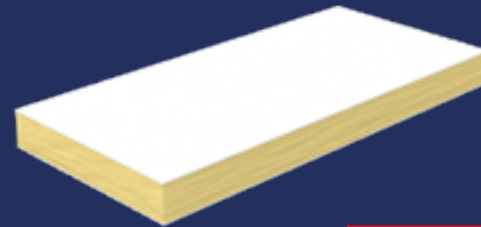

**FP320 FIRE BATT**  
A HIGH DENSITY COATED STONE WOOL BOARD



**FP311 INTUMESCENT GRAPHITE**  
SINGLE COMPONENT, WATER BASED, FIRE RETARDANT SEALING COMPOUND



**FP350 GRAPHITE PLATE**  
PRE-FORMED SELF-ADHESIVE INTUMESCENT PLATE



**FP370 FIRESEAL MORTAR**  
DRY WHITE POWDER CONSISTING OF INORGANIC COMPOUNDS AND PERLITE



**FP330 PIPE COLLAR**  
FIRE COLLAR THAT EXPANDS IN THE CASE OF A FIRE



**FP312 FIRE RETARDANT COATING**  
SPRAYABLE ABLATIVE COATING SPECIALLY DESIGNED TO ENHANCE, SEAL AND FIRE PROTECT STONE WOOL FIBRES



**FP360 PUTTY CORD**  
SILICON BASED HAND WORKABLE FIRE RATED PUTTY





# FIRE PROTECTION LINEAR JOINT SEALING

THE FIRE PROTECT PORTFOLIO HOLDS SEVERAL PRODUCTS THAT ARE ESPECIALLY DEVELOPED FOR USE IN LINEAR JOINT SEALING IN FIRE PROOF CONSTRUCTIONS

- 1 BOSTIK FP401 FIRESEAL ACRYLIC
- 2 BOSTIK FP403 FIRESEAL HYBRID
- 3 BOSTIK FP404 FIRE RETARDANT PU GUNFOAM



# CERTIFICATION & TESTING

The Bostik Fire Protect range complies to many well-known industry standard certifications. Below we highlight and explain the certification in more detail.



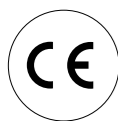

#### CE Classification (Europe)

In today's world globalization and harmonization have become common and familiar terms. This is also true at building standards and regulations. Within Bostik we embrace this movement and strive for a globalized standard which provides transparency and simplicity in sealing and bonding.



#### UL-EU

The UL-EU Mark is a voluntary pan-European certification Mark of Underwriters Laboratories for all products where an EN standard exists. UL-EU Mark is intended for use on products destined for the European marketplace. It means that UL has evaluated representative samples of a product or component and determined that those samples comply with the UL-EU Mark service requirements.



#### GEV-EMICODE® EC1 Plus

EMICODE® is a protected product classification system and at the same time an Eco label. Installation materials, adhesives and construction materials are submitted to a strict certification procedure where the quantity of emitted volatile organic compounds (VOC) is examined. When products come with the EC1 Plus certification, they can be easily adapted in the BREAAAM and LEED schemes.



#### M1 Certification

Various chemicals are emitted from building and interior decoration materials into indoor air. The classification presents emission requirements for the building materials, fixtures and furniture, with and without padding or textile coverings used in ordinary work spaces and residences with respect to good indoor air quality. M1 stands for low emissions.



#### A+ Certification

A+ is a compulsory French VOC emissions labelling of construction products installed indoors, based on emission testing. This regulation foresees that any covered product placed on the market has to be labelled with emission classes based on their emissions after 28 days, as tested with ISO 16000 and calculated for European reference room. The same holds true for EMICODE, GUT and Blue Angel. Also other valid information can be used as a basis for this assignment of class, such as tests based on ISO 16000, but with shorter testing duration.



# PASSIVE FIRE PROTECTION

- SAVES LIVES
- LIMITS MATERIAL DAMAGE LOSS
- MINIMISES BUSINESS LOSS
- PROTECTS THE BUILDING, WHICH MEANS IT IS ACCESSIBLE AFTER THE FIRE

#### ETA

The European Technical Assessment (ETA) is documented assessment of the performance of a construction product, in relation to its essential characteristics. This is the definition given by the Construction Products Regulation (CPR, Regulation (EU) No 305/2011), which governs the marketing of construction products in the European Economic Area. The ETA provides manufacturers with a voluntary way for CE marking their innovative non-standard construction product and thus bringing it to the European internal market. As an independent assessment, the ETA also contributes to create trust in the performance of the construction product related to its essential characteristics and taking into account its intended use(s). An ETA can be issued for construction products, if

1. they are not or not fully covered by any harmonised European Standard (hEN) and
2. the assessment methods and criteria have been laid down in a European Assessment Document (EAD).

The European Assessment Document (EAD) thus forms the basis for the European Technical Assessment. It contains the methods for assessing the product as well as specifications on the system for assessment and verification of constancy of performance (AVCP system) to be used. If the product in question is not yet (completely) covered by an existing EAD, EOTA will develop a new, or adapt an existing, European Assessment Document.

The ETA is valid in all EU Member States and those of the European Economic Area, as well as in Switzerland and Turkey. But it is also often accepted as technical documentation in other parts of the world. ETAs issued after the 1 July 2013, i.e. European Technical Assessments, are valid for an indefinite period of time.

#### DECLARATION OF PERFORMANCE

The ETA is the basis for a Declaration of Performance (DoP) which the manufacturer is required to draw up in accordance with the Construction Products Regulation (CPR) before CE-marking his product. The CE marking allows the manufacturer to freely market his product on the European internal market. By affixing the CE marking to the product, the manufacturer confirms that his product is in line with the applicable EU legislation and takes responsibility for the conformity of this product with the declared performance.



# EXPLANATION OF THE ICONS

The packaging of the Bostik Fire Protection range contain icons that tell something about the properties of the product. On the next page we explain in detail what these icons mean.



**EN 1366-4**  
Tested in accordance with EN 1366-4 /linear joints.



**EN 1366-3&4**  
Tested in accordance with EN 1366-3 / penetrations and EN 1366-4 / linear joints.



**EN 1366-3**  
Tested in accordance with EN 1366-3 / Service penetrations.



**EN ISO 10140-2**  
Tested in accordance with EN ISO 10140-2 sound insulation.



**EN ISO 13501-1**  
Tested in accordance with EN 13501-1 Fire class B-s1,d0



**EC1 Plus**  
Tested in accordance with EMICODE EC1 PLUS.



**Indoor use**  
The product can only be used indoor.



**Outside and indoor use**  
The product can be used indoor and outside.



**25% movement capability**  
The cured product is has a movement capability of 25%.



**Hand held**  
The product is a hand held foam / straw foam.



**Gungrade**  
The product is a gun grade foam suitable for use with PU foam guns.



**Electric**  
The product is tested for use with cables and conduits.



**Sealing pipes**  
The product is suitable for sealing service penetration gaps around pipes.



# ABOUT BOSTIK

**BOSTIK HAS GROWN SINCE THE COMPANY WAS FOUNDED TO A LEADING GLOBAL PLAYER IN THE FIELD OF ADHESIVE AND SEALING SOLUTIONS. THROUGH GREAT INVOLVEMENT WITH CUSTOMERS AND THE TRANSLATION OF CRAFTSMANSHIP TOWARDS PRACTICAL APPLICATIONS, WE WANT TO CONTINUE GROW INTO YOUR RESPECTED PRODUCER AND PARTNER IN CONNECTION TECHNOLOGIES.**

- 130 years of experience in the development of smart adhesives
- Annual turnover around 2 billion euros
- More than 6,000 employees worldwide
- Active in more than 55 countries
- More than 500 employees for development & technology
- Part of Arkema



**BOSTIK BENELUX B.V.**  
**P: + 31 (0)162 491 000**  
Denariusstraat 11, 4903 RC, Oosterhout The Netherlands  
E: [info.benelux@bostik.com](mailto:info.benelux@bostik.com)

Adhesive solutions by **ARKEMA**